



NEHRU COLLEGE OF ENGINEERING AND RESEARCH CENTRE
(NAAC Accredited)
(Approved by AICTE, Affiliated to APJ Abdul Kalam Technological University, Kerala)



DEPARTMENT OF MECHANICAL ENGINEERING

COURSE MATERIALS



ME220 MANUFACTURING TECHNOLOGY

VISION OF THE INSTITUTION

To mould true citizens who are millennium leaders and catalysts of change through excellence in education.

MISSION OF THE INSTITUTION

NCERC is committed to transform itself into a center of excellence in Learning and Research in Engineering and Frontier Technology and to impart quality education to mould technically competent citizens with moral integrity, social commitment and ethical values.

We intend to facilitate our students to assimilate the latest technological know-how and to imbibe discipline, culture and spiritually, and to mould them in to technological giants, dedicated research scientists and intellectual leaders of the country who can spread the beams of light and happiness among the poor and the underprivileged.

ABOUT DEPARTMENT

- ◆ Established in: 2002
- ◆ Course offered : B.Tech in Mechanical Engineering
- ◆ Approved by AICTE New Delhi and Accredited by NAAC
- ◆ Affiliated to the University of Dr. A P J Abdul Kalam Technological University.

DEPARTMENT VISION

Producing internationally competitive Mechanical Engineers with social responsibility & sustainable employability through viable strategies as well as competent exposure oriented quality education.

DEPARTMENT MISSION

1. Imparting high impact education by providing conducive teaching learning environment.
2. Fostering effective modes of continuous learning process with moral & ethical values.
3. Enhancing leadership qualities with social commitment, professional attitude, unity, team spirit & communication skill.
4. Introducing the present scenario in research & development through collaborative efforts blended with industry & institution.

PROGRAMME EDUCATIONAL OBJECTIVES

PEO1: Graduates shall have strong practical & technical exposures in the field of Mechanical Engineering & will contribute to the society through innovation & enterprise.

PEO2: Graduates will have the demonstrated ability to analyze, formulate & solve design engineering / thermal engineering / materials & manufacturing / design issues & real life problems.

PEO3: Graduates will be capable of pursuing Mechanical Engineering profession with good communication skills, leadership qualities, team spirit & communication skills.

PEO4: Graduates will sustain an appetite for continuous learning by pursuing higher education & research in the allied areas of technology.

PROGRAM OUTCOMES (POS)

Engineering Graduates will be able to:

1. **Engineering knowledge:** Apply the knowledge of mathematics, science, engineering fundamentals, and an engineering specialization to the solution of complex engineering problems.
2. **Problem analysis:** Identify, formulate, review research literature, and analyze complex engineering problems reaching substantiated conclusions using first principles of mathematics, natural sciences, and engineering sciences.
3. **Design/development of solutions:** Design solutions for complex engineering problems and design system components or processes that meet the specified needs with appropriate consideration for the public health and safety, and the cultural, societal, and environmental considerations.
4. **Conduct investigations of complex problems:** Use research-based knowledge and research methods including design of experiments, analysis and interpretation of data, and synthesis of the information to provide valid conclusions.
5. **Modern tool usage:** Create, select, and apply appropriate techniques, resources, and modern engineering and IT tools including prediction and modeling to complex engineering activities

with an understanding of the limitations.

6. **The engineer and society:** Apply reasoning informed by the contextual knowledge to assess societal, health, safety, legal and cultural issues and the consequent responsibilities relevant to the professional engineering practice.
7. **Environment and sustainability:** Understand the impact of the professional engineering solutions in societal and environmental contexts, and demonstrate the knowledge of, and need for sustainable development.
8. **Ethics:** Apply ethical principles and commit to professional ethics and responsibilities and norms of the engineering practice.
9. **Individual and teamwork:** Function effectively as an individual, and as a member or leader in diverse teams, and in multidisciplinary settings.
10. **Communication:** Communicate effectively on complex engineering activities with the engineering community and with society at large, such as, being able to comprehend and write effective reports and design documentation, make effective presentations, and give and receive clear instructions.
11. **Project management and finance:** Demonstrate knowledge and understanding of the engineering and management principles and apply these to one's own work, as a member and leader in a team, to manage projects and in multidisciplinary environments.
12. **Life-long learning:** Recognize the need for, and have the preparation and ability to engage in independent and life-long learning in the broadest context of technological change.

PROGRAM SPECIFIC OUTCOMES (PSO)

PSO1: Students will be to apply principles of engineering, basic sciences & analytics including multi variant calculus & higher order partial differential equations..

PSO2: Students will be to perform modeling, analyzing, designing & simulating physical systems, components & processes.

PSO3: Students will be to work professionally on mechanical systems, thermal systems & production systems.

COURSE OUTCOMES

CO 1	Explain various casting processes, procedures of doing it, application of each processes and casting defects.
CO 2	Discuss various rolling processes, analysis of rolling force and power requirement and its applications.
CO 3	Discuss various forging methods and extrusion processes and its applications.
CO 4	Discuss the principles and classification of locating elements and clamping devices.
CO 5	Discuss the sheet metal operations and their applications to produce various shapes and products.
CO 6	Classify different welding processes and selection of process parameters.

MAPPING OF COURSE OUTCOMES WITH PROGRAM OUTCOMES

	PO1	PO2	PO3	PO4	PO5	PO6	PO7	PO8	PO9	PO10	PO11	PO12	PSO1	PSO2	PSO3
CO1	3	2	-	-	-	-	-	-	-	-	-	3	3	3	3
CO2	3	3	2	-	-	-	-	-	-	-	-	3	2	3	3
CO3	3	2	-	-	-	-	-	-	-	-	-	3	3	3	3
CO4	3	-	2	-	-	-	-	-	-	-	-	3	2	3	3
CO5	3	2	2	-	-	-	-	-	-	-	-	3	2	3	3
	3	-	2	-	2	-	-	-	-	-	-	3	2	3	3

Note: H-Highly correlated=3, M-Medium correlated=2, L-Less correlated=1

SYLLABUS

Course No.	Course Name	L-T-P-Credits	Year of Introduction
ME220	MANUFACTURING TECHNOLOGY	3-0-0-3	2016
Prerequisite: Nil			
Course Objectives:- <ol style="list-style-type: none">1. To give an exposure to different techniques of casting and molds required.2. To provide an exposure to different rolling processes and different rolled products3. To familiarize with different forging methods, cautions to be adopted in die design.4. To give an introduction to various work and tool holding devices used in manufacturing.5. To introduce to the bending, shearing and drawing processes of sheet metal working and allied machines,6. To give an understanding of welding metallurgy and weldability and to introduce various metal joining techniques.			
SYLLABUS Casting –patterns - Cores – Gating – Riser – Defects in Castings - Rolling –Defects in Rolled parts- forging – Coining – Heading – Piercing –Die Design– Extrusion Process– Extrusion Defects – Drawing Process -Principles of Location –Principles of Clamping – Types of Clamp -Sheet metal characteristics –Deep drawing –Spinning –Definition of Welding – Weldability – Solidification of Weld Metal – Heat Affected Zone – Welding Defects - Gas Welding -Arc Welding - Ultrasonic Welding – Friction Welding – Resistance Welding – Brazing- Soldering.			
Expected outcomes: At the end of the course the students will be able to <ol style="list-style-type: none">1. Acquire knowledge in various casting processes and technology related to them.2. Understand the rolling passes required for getting required shapes of rolled products.3. Discuss important aspects of forging techniques4. Discuss sheet metal working processes and their applications to produce various shapes and products.5. Acquire knowledge in various types of welding processes.			
Text books:- <ol style="list-style-type: none">1. Amitabha Ghosh and Ashok Kumar Mallick, Manufacturing Science Affiliated East West Press Ltd, New Delhi, 20022. S.Kalpakjian and Steven R Schmid, Manufacturing Engineering and Technology, Pearson,2001			
Reference books:- <ol style="list-style-type: none">1. RAO, Manufacturing Technology-Vol 2 3e, McGraw Hill Education India, 20132. RAO, Manufacturing Technology-Vol 1 4e, McGraw Hill Education India, 20133. Cyril Donaldson and George H LeCain, Tool Design, TMH4. Handbook of Fixture Design – ASTME5. Campbell J. S., Principles of Manufacturing Materials and Processes, Tata McGraw Hill, 19996. P R Beeley, Foundry Technology, Elsevier, 20017. Richard W. Heine, Carl R. Loper, Philip C. Rosenthal, Principles of Metal Casting,			

- Tata McGraw-Hill Education, 2001
8. Paul Degarma E and Ronald A. Kosher ,Materials and Processes in Manufacturing, Wiley,2011
 9. P. N. Rao,Manufacturing Technology Foundry, Forming and Welding, Tata McGraw-Hill Education,2011
 10. HMT Production Technology, 1e McGraw Hill,2001

APJ ABDUL KALAM
TECHNOLOGICAL
UNIVERSITY

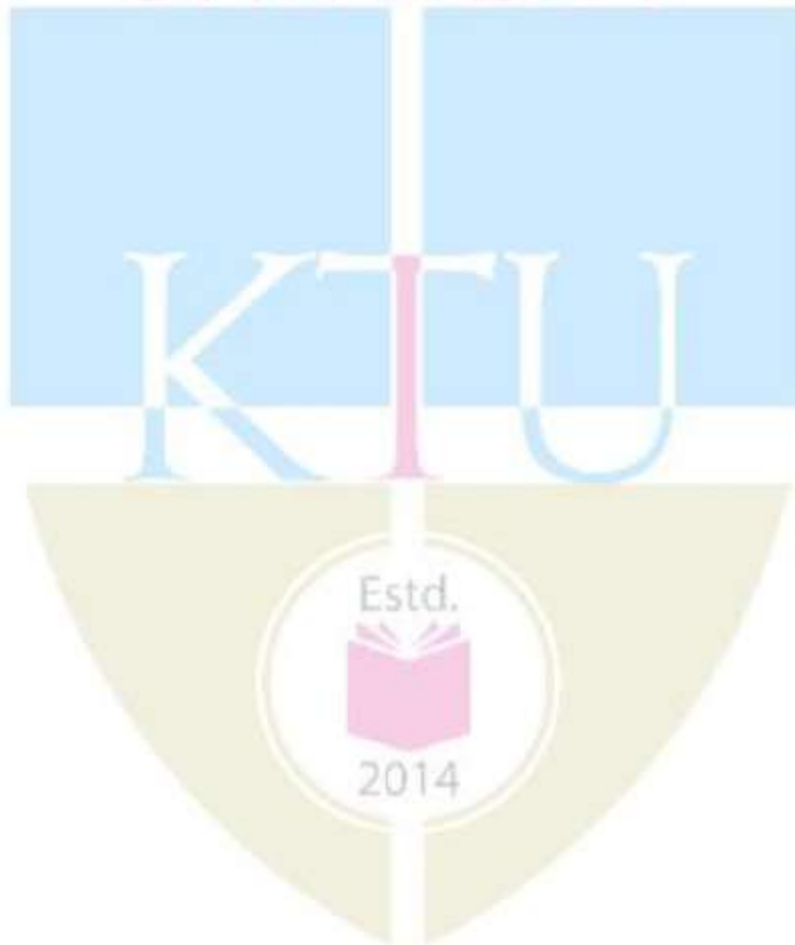

Course Plan			
Module	Contents	Hours	Semester Examination Marks
I	Sand Casting – Sand Molds-Types of Molding Sands and Testing	1	15%
	Type of patterns - Pattern Materials	1	
	Cores –Types and applications –Sand Molding Machines	1	
	Gating System – Riser	1	
	Shell Mold Casting – Ceramic Mold Casting	1	
	Investment Casting – Vacuum Casting – Slush Casting	1	
	Pressure Casting – Die Casting – Centrifugal Casting	1	
	Design Considerations based on Various Shapes - Defects in Castings – simple problems in casting	1	
II	Principles of Rolling –Types of rolling mills, Mechanics of Flat Rolling	1	15%
	Roll Force and Power Requirement - Neutral Point	1	
	Hot and Cold Rolling	1	
	Defects in Rolled Plates - Rolling Mills	1	
	Ring Rolling – Thread Rolling	1	
	Applications- Rolling of tubes, wheels, axles and I-beams	1	
FIRST INTERNAL EXAM			
III	Classification of forging – Forging methods – Forging under sticking condition	1	15%
	Precision Forging – Coining – Heading – Piercing	1	
	Die Design:- Preshaping, Design Features, Draft Angles – Die Materials and Lubrication	1	
	Forging Machines – Forging Defects and tests	1	
	Extrusion Process - Hot Extrusion – Cold Extrusion	1	
	Impact Extrusion – Extrusion Defects – Drawing Process, wire drawing process	1	

IV	Principles Location - Degrees of Freedom, 3-2-1 principle of locating	1	15%
	Locating from Planes - Locating from Circular Surfaces	1	
	Concentric Locating - Principles of Clamping	1	
	Types of Clamps - Strap Clamps Slide Clamps - Swing Clamps - Hinge Clamps	1	
	Vacuum Clamping - Magnetic Clamping	1	
SECOND INTERNAL EXAM			
V	Sheet metal characteristics – Typical shearing	1	20%
	Bending Sheet and Plate – Spingback - Bending Force	1	
	Press Brake Forming - Tube Bending	1	
	Stretch Forming - Deep Drawing	1	
	Rubber forming - Spinning Shear Spinning - Tube Spinning	1	
	Definition of Welding - Weldability – Solidification of the Weld Metal	1	
	Heat Affected Zone – correlation of strength of welded joint with structure - Welding Defects	1	
VI	Gas Welding: – Flame Characteristics	1	20%
	Equipment, fluxes and filler rods	1	
	Arc Welding – Applications and Equipment	1	
	Electrodes	1	
	Shielded Metal Arc Welding – Submerged Arc Welding	1	
	GTAW – Plasma Arc Welding	1	
	Ultrasonic Welding – Friction Welding	1	
	Resistance Spot Welding	1	
	Resistance Seam Welding – Stud Welding – Percussion Welding - simple problems in welding	1	
	Brazing:- Filler Metals, Methods - Soldering:- Techniques, Types of Solders and Fluxes	1	
END SEMESTER EXAM			

QUESTION BANK

MODULE I

Q:NO:	QUESTIONS	CO	KL
1	Analyze the importance of gating system and risering in casting with the help of neat figure.	CO1	K4
2	Identify and explain about different types of centrifugal casting with the help of neat sketch.	CO1	K2
3	With a neat sketch, analyze the steps in shell moulding process. List advantages and applications of the process.	CO1	K4
4	List different types of defects in casting, write its causes and remedies.	CO1	K1
5	Analyze the sand casting process in detail, what are the advantages and disadvantages.	CO1	K4
6	List the type of patterns and pattern materials.	CO1	K2
7	With a neat sketch, analyze the steps in Investment casting. List advantages, disadvantages and applications of the process.	CO1	K4
8	Elaborate four desirable properties of moulding sand.	CO1	K4
9	Discuss the function of core in casting process and mention any two types.	CO1	K2

MODULE II

1	Identify and explain about the various defects in rolled parts.	CO3	K2
2	Analyze the process ring rolling.	CO3	K4
3	Describe about the process Thread rolling.	CO3	K2
4	Differentiate between hot rolling and cold rolling.	CO3	K1

5	With the aid of sketches write short note on the following: Two high mills, Three high mills and Four high mills.	CO3	K2
6	Elaborate the concept of roll deflection and roll flattening.	CO3	K2
7	Define the terms Neutral point and Angle of bite.	CO3	K4
8	What is campering of rolls? Why is it required?	CO3	K2
9	Elaborate (i) rolling of tubes (ii) wheels.	CO3	K1

MODULE III

1	Analyze the concept of Forging. Write its advantages and disadvantages	CO4	K4
2	Compare forged part with cast part	CO4	K1
3	Identify and explain about any three types of extrusion defects	CO4	K2
4	With neat figures explain about the different methods of extrusion	CO4	K1
5	Compare hot extrusion and cold extrusion	CO4	K1
6	With the help of neat sketches. Explain the differences between open die forging and closed die forging	CO4	K2
7	Analyze the steps involved in drop forging with neat sketch	CO4	K4
8	Elaborate the steps in rod and wire drawing process.	CO4	K2

MODULE IV

1	With neat figure explain about different types of locating methods.	CO4	K2
2	With neat figure explain 3-2-1 principle.	CO4	K4
3	With neat figure explain degrees of freedom with respect to a work-piece.	CO4	K4
4	With neat figures explain about different types of strap clamps.	CO4	K2
5	Describe principles of clamping.	CO4	K1

6	Differentiate between locating from planes and locating from circular surfaces.	CO4	K4
7	With neat figures Explain vacuum and magnetic clamping	CO4	K3
8	Describe with neat sketches the working principle of Strap clamp and Slide clamp.	CO4	K2

MODULE V

1	With neat figure explain HAZ	CO5	K3
2	Write note on the following weld defects: cracks, distortion and lack of penetration.	CO5	K2
3	With the help of neat sketches explain metallurgy of a steel weld and the various regions in the weld.	CO5	K3
4	Differentiate between blanking and punching.	CO5	K4
5	What is spring back? What are the reasons and how can it is avoided?	CO5	K4
6	With neat figure explain (i) Deep drawing (ii) Stretch forming.	CO5	K2
7	With neat figure explain (i) rubber forming (ii) Tube spinning.	CO5	K2
8	Explain any five sheet metal characteristics.	CO5	K4

MODULE VI

1	What are the different types of welding techniques used in gas welding? Compare them.	CO2	K2
2	With neat figure explain Ultrasonic welding. Also write its advantages and disadvantages.	CO2	K4
3	With neat figure explain submerged arc welding process. Also write its advantages and disadvantages.	CO2	K4
4	With neat figure explain Flux shielded metal arc welding process. Also write its advantages and disadvantages.	CO2	K4
5	Identify and explain about the flame characteristics of gas welding process.	CO2	K1

6	Define soldering. Also explain in detail about soldering techniques, types of solders and fluxes used in soldering.	CO2	K2
7	With neat figure explain resistance spot welding process. Also write its advantages and disadvantages.	CO2	K2
8	Analyze the different types of fluxes and filler materials used in gas welding process.	CO2	K4

APPENDIX 1

CONTENT BEYOND THE SYLLABUS

Sl: NO.	WEB SOURCE REFERENCES
1	https://www.researchgate.net/publication/280053102_Advanced_Casting_Methodologies_Investment_Casting_Centrifugal_Casting_Squeeze_Casting_Metal_Spinning_and_Batch_Casting
2	https://www.wileymetal.com/6-advanced-welding-processes-and-their-applications-explained/
3	https://www.ndt.net/article/panndt2007/papers/143.pdf
4	https://www.forgingmagazine.com/issues-and-ideas/article/21923033/new-developments-in-forging-technology
5	https://www.forging.org/producers-and-suppliers/technology/vision-of-the-future

MODULE-1

SAND CASTING

Introduction

Casting is the first step in manufacturing most products. In this process, the material is first liquefied by properly heating it in a suitable furnace. Then, the liquid is poured into a previously prepared mould cavity where it is allowed to solidify. Subsequently, the product is taken out of the mould cavity, trimmed, and cleaned to shape.

Sand casting consists of:

- Placing a pattern having the shape of the desired casting in sand to make an imprint,
- Incorporating a gating system,
- Filling the resulting cavity with molten metal,
- Allowing the metal to cool until it solidifies,
- Breaking away the sand mold, and
- Removing the casting.

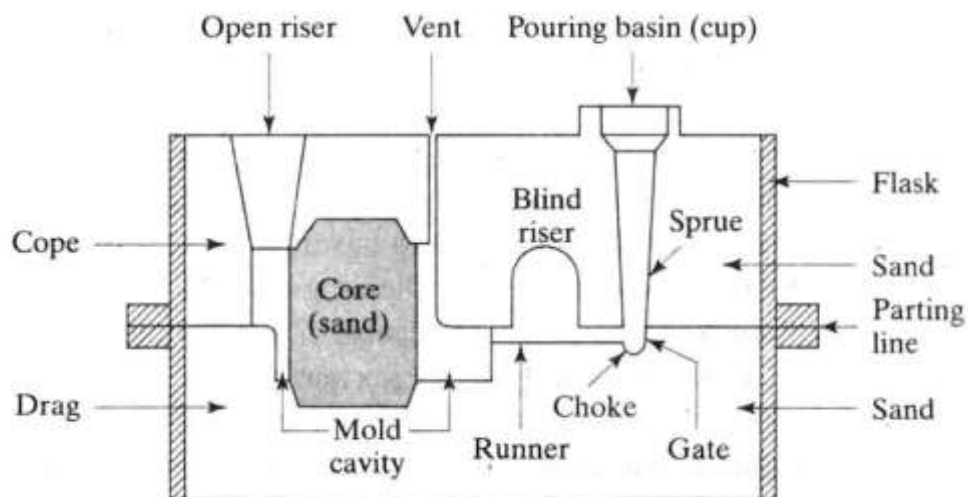

Fig:1.1: Schematic illustration of a sand mold, showing various features

The production steps for a typical sand-casting operation are shown in following figure.

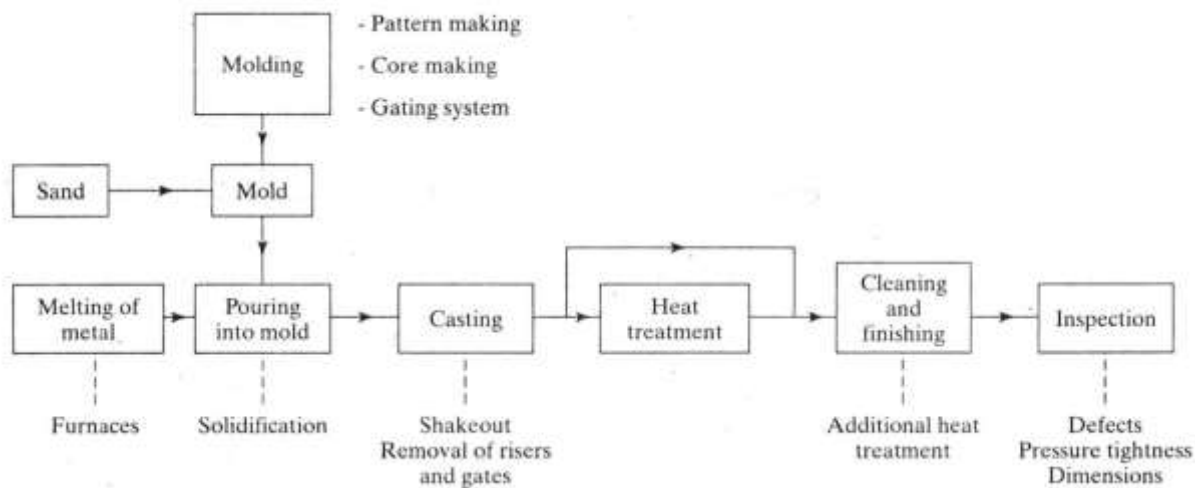

Fig. 1.2: Outline of production steps in a typical sand-casting operation

SAND MOULD

Most sand casting operations use silica sand (SiO_2). Silica sand is the product of the disintegration of rocks over extremely long periods of time. Sand is inexpensive and is suitable as mold material because of its resistance to high temperatures. There are two general types of sand:

- a) Naturally bonded (bank sand) and
- b) Synthetic (lake sand).

Synthetic sand is preferred by most foundries because its composition can be controlled more accurately. Several factors are important in the selection of sand for molds. Sand having *fine, round grains* can be closely packed and forms a smooth mold surface. Good *permeability* of molds and cores allows gases and steam evolved during casting to escape easily.

The mold should have good *collapsibility* (to allow for the casting to shrink while cooling) to avoid defects in the casting, such as hot tearing and cracking. Sand is typically conditioned before use. Mulling machines are used to uniformly and thoroughly mull (mix) sand with additives. Clay (bentonite) is used as a cohesive agent to bond sand particles, giving the sand strength. Zircon (ZrSiO_4), olivine (Mg_2SiO_4), and iron silicate (Fe_2SiO_4) sands are often used in steel foundries for their low thermal expansion. Chromite (FeCr_2O_4) is used for its high heat-transfer characteristics.

Major components of a sand mold

1. The mold itself, which is supported by a *flask*. Two-piece molds consist of a *cope* on top and a *drag* on the bottom. The seam between them is the parting line. When more than two pieces are used, the additional parts are called *cheeks*.
2. A *pouring basin* or *pouring cup*, into which the molten metal is poured.
3. A *sprue*, through which the molten metal flows downward.
4. The *runner system*, which has channels that carry the molten metal from the sprue to the mold cavity. *Gates* are the inlets into the mold cavity.
5. *Risers*, which supply additional metal to the casting as it shrinks during solidification Figure 1.1 shows two different types of risers: a *blind riser* and an *open riser*.
6. *Cores*, which are inserts made from sand. They are placed in the mold to form hollow regions or otherwise define the interior surface of the casting. Cores are also used on the outside of the casting to

form features such as lettering on the surface of a casting or deep external pockets.

7. **Vents**, which are placed in molds to carry off gases produced when the molten metal comes into contact with the sand in the mold and core. They also exhaust air from the mold cavity as the molten metal flows into the mold.

Types of sand moulds

Three basic types of sand molds:

- a. Green-sand
- b. cold-box, and
- c. no-bake molds

Green molding sand

It is a mixture of sand, clay, and water. The sand in the mold is moist or damp while the metal is being poured into it. Hence the term “Green” is used. It is the least expensive method of making molds.

Skin dried mold

The mold surfaces are dried, either by storing the mold in air or by drying it with torches. These molds are generally used for large castings because of their higher strength.

Oven dried (baked) mold

Sand molds are also oven dried (baked) prior to pouring the molten metal. They are stronger than green-sand molds and impart better dimensional accuracy and surface finish to the casting.

There are some drawbacks for oven dried molds:

- a. Distortion of the mold is greater;
- b. The castings are more susceptible to hot tearing because of the lower collapsibility of the mold; and
- c. The production rate is slower because of the drying time required.

Cold-box mold

Various organic and inorganic binders are blended into the sand to bond the grains chemically for greater strength. These molds are dimensionally more accurate than green-sand molds but are more expensive.

No-bake mold

A synthetic liquid resin is mixed with the sand; the mixture hardens at room temperature. Because bonding of the mold in this and in the cold-box process takes place without heat, they are called cold-setting processes.

PATTERNS

Patterns are used to mold the sand mixture into the shape of the casting. They may be made of wood, plastic, or metal. The selection of a pattern material depends on the size and shape of the casting, the dimensional accuracy, the quantity of castings required, and the molding process (Table 1.1).

CHARACTERISTIC	RATING				
	Wood	Aluminium	Steel	Plastic	Cast Iron
Machinability	E	G	F	G	G
Wear resistance	P	G	E	F	E
Strength	F	G	E	G	G
Weight	E	G	P	G	P
Repairability	E	P	G	F	G
Resistance to corrosion	E	E	P	E	P
Resistance to swelling	P	E	E	E	E

E: Excellent, G: Good, F: Fair, P: Poor Table 1.1:

Characteristics of Pattern Materials

Because patterns are used repeatedly to make molds, the strength and durability of material selected for patterns must reflect the number of castings that the mold will produce. They may be made of a combination of materials to reduce wear in critical regions. Patterns are usually coated with a parting agent to facilitate their removal from the molds.

Types of Patterns

The commonly-used patterns are classified as follows:

Loose pattern

It is made in one piece, usually from wood, and is used for castings numbering up to 100.

Gated pattern

This is simply one or more than one loose pattern with attached gates and runners and provides a channel through which the molten metal can flow from the pouring sprue to the mould cavity. This pattern is frequently set on a follow board conforming to the parting surface of the mould. The follow board helps in an easy removal of the pattern after the mould has been prepared.

Match plate pattern

This pattern is made in two halves mounted on both sides of a match plate (of wood or metal) conforming to the contour of the parting surface. The match plate is accurately placed between the cope and the drag flasks by means of locating pins. For small castings, several patterns can be mounted on the same match plate.

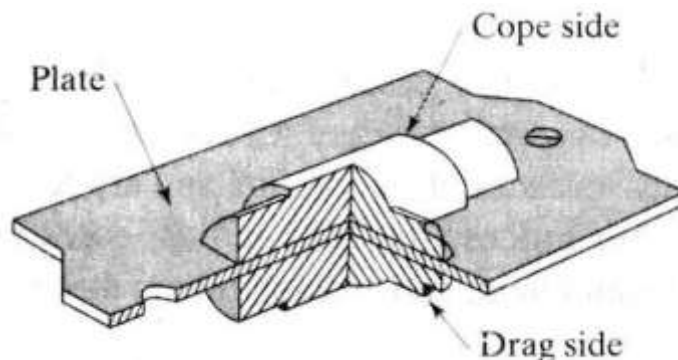

Fig: 1.3: Match plate pattern

Cope and drag pattern

Here, the cope and drag halves of a split pattern are separately mounted on two match plates. Thus, the cope and the drag flasks are made separately and brought together (with accurate relative location) to produce the complete mould.

Sweep pattern

Normally made of wood, it is used to generate surfaces of revolution in large castings, and to prepare moulds out of a paste-like material. Here, "sweep" refers to the section that rotates about an edge to yield circular sections.

Skeleton pattern

This consists of a simple wooden frame outlining the shape of the casting. It is used to guide the moulder for hand-shaping the mould and for large castings having simple geometrical shapes.

CORES

For castings with internal cavities or passages, such as those found in an automotive engine block or a valve body, cores are utilized. Cores are placed in the mold cavity before casting to form the interior surfaces of the casting and are removed from the finished part during shakeout and further processing. Like molds, cores must possess strength, permeability, ability to withstand heat, and collapsibility; therefore, cores are made of sand aggregates.

The core is anchored by core prints. These are recesses that are added to the pattern to support the core and to provide vents for the escape of gases (Fig. 1.4). A common problem with cores is that for some casting requirements, as in the case where a recess is required, they may lack sufficient structural support in the cavity. To keep the core from shifting, metal supports (chaplets) may be used to anchor the core in place (Fig. 1.4).

Cores are generally made in a manner similar to that used in making molds; the majority are made with shell, no-bake, or cold-box processes. Cores are formed in core boxes, which are used in much the same way that patterns are used to form sand molds. The sand can be packed into the boxes with sweeps, or blown into the box by compressed air from core blowers. The latter have the advantages of producing uniform cores and operating at very high production rates.

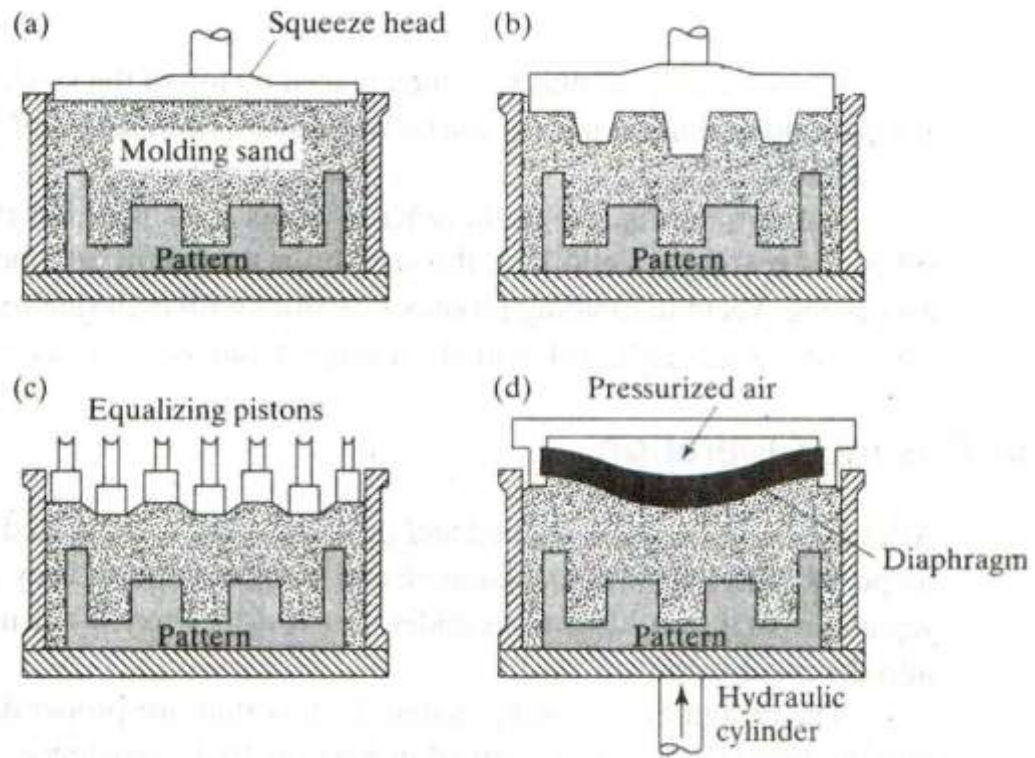

Fig 1.5: Various designs of squeeze heads for mold making: (a) conventional flat head; (b) profile head; (c) equalizing squeeze pistons; and (d) flexible diaphragm.

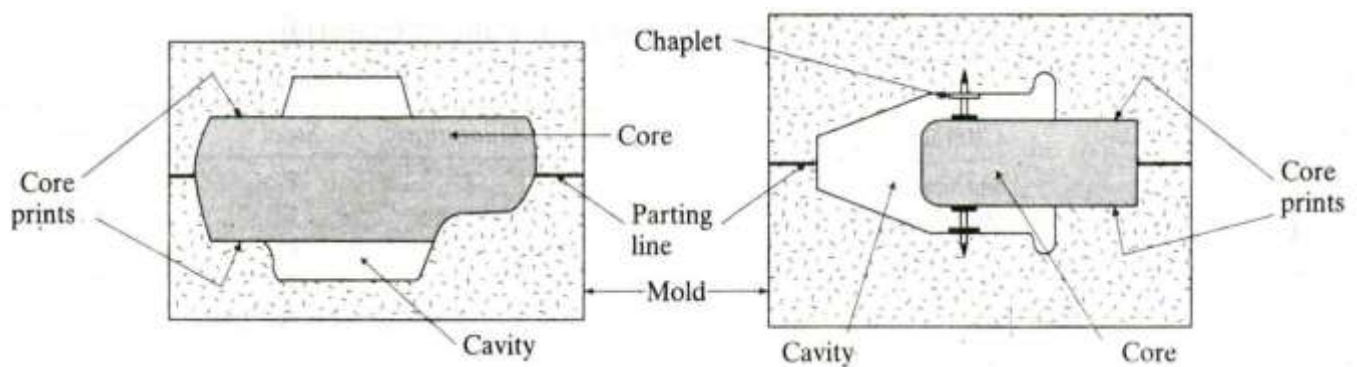

Fig: 1.4: Examples of sand cores showing core prints and chaplets to support cores.

SAND-MOLDING MACHINES

For most operations, the sand mixture is compacted around the pattern by molding machines (Fig 1.5). These machines eliminate arduous labor, offer high-quality casting by improving the application and distribution of forces, manipulate the mold in a carefully controlled manner and increase production rate.

Mechanization of the molding process can be further assisted by jolting the assembly. The flask, molding sand, and pattern are first placed on a pattern plate mounted on an anvil, and then jolted upward by air

pressure at rapid intervals. The inertial forces compact the sand around the pattern. Jolting produces the highest compaction at the horizontal parting line, whereas in squeezing, compaction is highest at the squeezing head (Fig 1.5). Thus, more uniform compaction can be obtained by combining squeezing and jolting.

Vertical flaskless molding

In vertical flaskless molding, the halves of the pattern form a vertical chamber wall against which sand is blown and compacted. Then, the mold halves are packed horizontally, with the parting line oriented vertically and moved along a pouring conveyor. This operation is simple and eliminates the need to handle flasks, allowing for very high production rates, particularly when other aspects of the operation (such as coring and pouring) are automated.

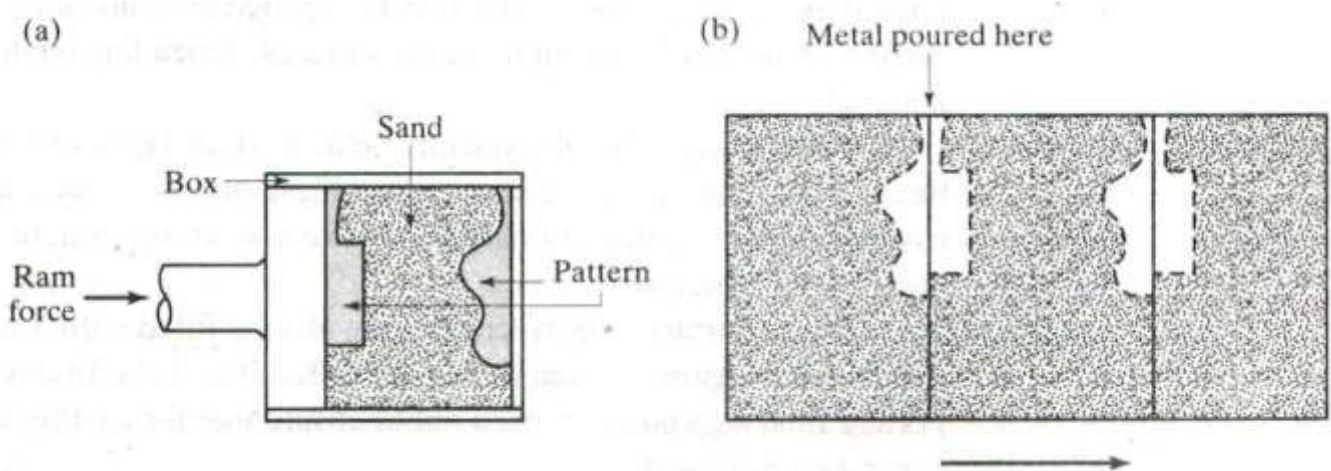

Sandslingers fill the flask uniformly with sand under high-pressure stream. They are used to fill large flasks and are typically operated by machine. An impeller in the machine throws sand from its blades or cups at such high speeds that the machine not only places the sand but also rams it appropriately.

Impact molding

In impact molding, the sand is compacted by controlled explosion or instantaneous release of compressed gases. This method produces molds with uniform strength and good permeability.

Vacuum molding

In vacuum molding, also known as the "V" process, the pattern is covered tightly by a thin sheet of plastic. A flask is placed over the coated pattern and is filled with dry binderless sand. A second sheet of plastic is then placed on top of the sand, and a vacuum action hardens the sand so that the pattern can be withdrawn. Both halves of the mold are made this way and assembled.

During pouring, the mold remains under a vacuum but the casting cavity does not. When the metal has solidified, the vacuum is turned off and the sand falls away, releasing the casting. Vacuum molding produces castings with high-quality detail and dimensional accuracy. It is especially well suited for large, relatively flat castings.

THE SAND-CASTING OPERATION

After the mold has been shaped and the cores have been placed in position, the two halves (cope and drag) are closed, clamped, and weighted down. They are weighted to prevent the separation of the mold sections under the pressure exerted when the molten metal is poured into the mold cavity.

After solidification, the casting is shaken out of its mold, and the sand and oxide layers adhering to the casting are removed by vibration (using a shaker) or by sand blasting. Ferrous castings are also cleaned by blasting with steel shot (shot blasting) or grit. The risers and gates are cut off by oxyfuel-gas cutting, sawing, shearing, and abrasive wheels, or they are trimmed in dies. Gates and risers on steel castings are also removed with air carbon-arc or powder-injection torches. Castings may be cleaned by electro chemical means or by pickling with chemicals to remove surface oxides.

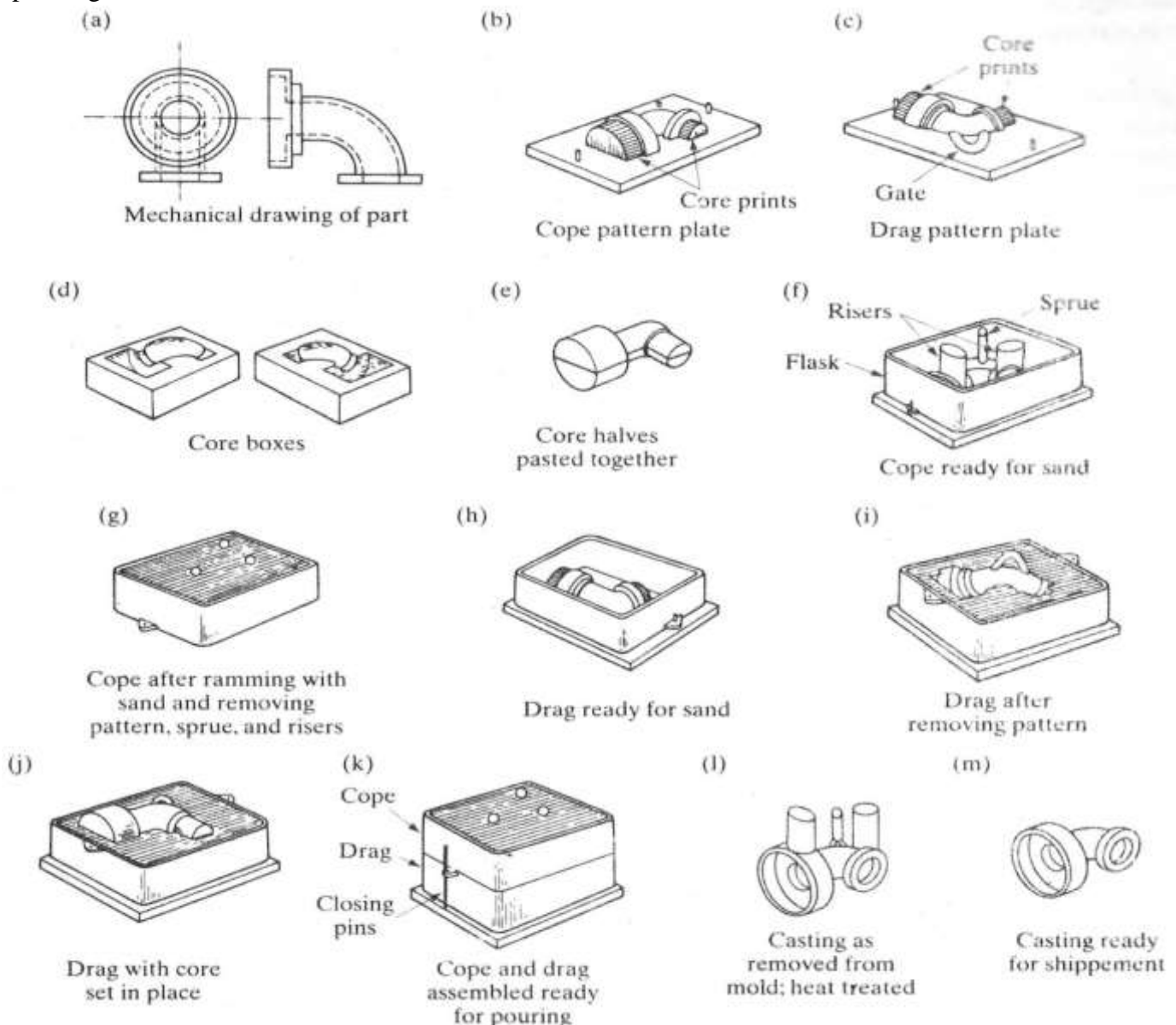

Fig 1.6: Schematic illustration of the sequence of operations for sand casting

GATING SYSTEM

A good gating design ensures distribution of the metal in the mould cavity at a proper rate without excessive temperature loss, turbulence, and entrapping gases and slags. If the liquid metal is poured very slowly, then the time taken to fill up the mould is rather long and the solidification may start even before the mould has been completely filled up. This can be avoided by using too much superheat, but then gas solubility may cause a problem. On the other hand, if the liquid metal impinges on the mould cavity with too high a velocity, the mould surface may be eroded. Thus, a compromise has to be made in arriving at an optimum velocity.

Broadly, gating designs can be classified into three categories, namely,

- a) Vertical gating,
- b) Bottom gating, and
- c) Horizontal gating.

Vertical gating

In vertical gating, the liquid metal is poured vertically to fill the mould with atmospheric pressure at the base.

Bottom gating

In bottom gating, on the other hand, the liquid metal is filled in the mould from bottom to top, thus avoiding the splashing and oxidation associated with vertical gating. Figure 1.7 shows a simple vertical gating and a bottom gating design.

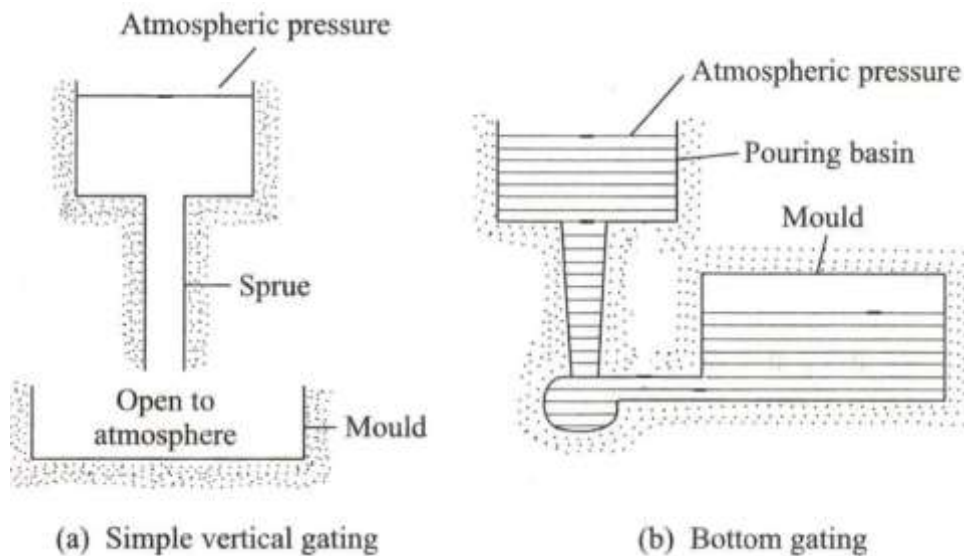

Horizontal gating

In the horizontal gating system, additional horizontal portions are introduced for better distribution of the liquid metal with minimum turbulence.

SHELL MOLD CASTING

In this process,

A mounted pattern made of a ferrous metal or aluminum is heated to 175°C - 370°C , coated with a parting agent such as silicone, and clamped to a box or chamber.

The box contains fine sand, mixed with 2.5% to 4% thermosetting resin binder (such as phenol-formaldehyde) that coats the sand particles. The box is either rotated upside down (Fig. 1.8) or the sand mixture is blown over the pattern, allowing it to coat the pattern.

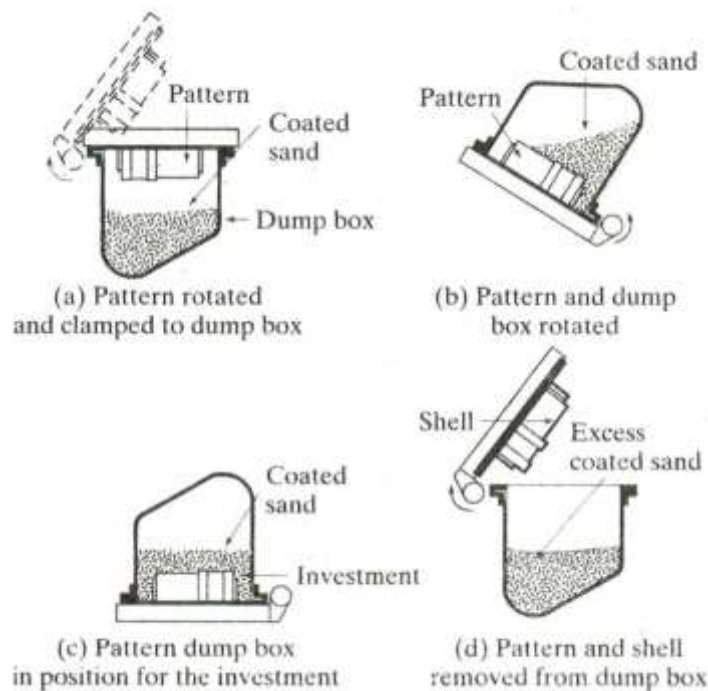

Fig 1.8: A common method of making Shell Molds (Dumpbox technique)

The assembly is then placed in an oven for a short period of time to complete the curing of the resin. In most shell-molding machines the oven is a metal box with gas-fired burners that swing over the shell mold to cure it. The shell hardens around the pattern and is removed from the pattern using built-in ejector pins. Two half-shells are made in this manner and are bonded or clamped together in preparation for pouring.

The thickness of the shell can be accurately determined by controlling the time that the pattern is in contact with the mold. In this way, the shell can be formed with the required strength and rigidity to hold the weight of the molten liquid.

Shell sand has a much lower permeability than sand used for green sand molding because a sand of much smaller grain size is used for shell molding.

Shell molds are generally poured with the parting line horizontal and may also be supported by sand. The walls of the mold are relatively smooth, offering low resistance to flow of the molten metal and producing castings with sharper comers, thinner sections, and smaller projections than are possible in green-sand molds. With the use of multiple gating systems, several castings can be produced in a single mold.

The high quality of the finished casting can significantly reduce cleaning, machining, and other finishing costs. Complex shapes can be produced with less labor, and the process can be automated fairly easily. Shell-molding applications include small mechanical parts requiring high precision, such as gear housings, cylinder heads, and connecting rods. The process is also widely used in producing high-precision molding cores.

CERAMIC MOLD CASTING

The ceramic-mold casting process is also known as *cope-and-drag investment casting*. It uses refractory mold materials suitable for high-temperature applications. A slurry, a mixture of fine-grained $ZrSiO_4$, aluminum oxide, and fused silica, which are mixed with bonding agents and poured over the pattern (Fig. 1.9), which has been placed in a flask.

The pattern may be made of wood or metal. After setting, the molds (ceramic facings) are removed, dried, burned off to remove volatile matter, and baked. The molds are clamped firmly and used as all-ceramic molds.

The high-temperature resistance of the refractory molding materials allows these molds to be used in casting ferrous and other high-temperature alloys, stainless steels, and tool steels. The castings have good dimensional accuracy and surface finish over a wide range of sizes and intricate shapes, but the process is somewhat expensive. Typical parts made are impellers, cutters for machining operations, dies for metalworking, and molds for making plastic or rubber components. Parts weighing as much as 700 kg have been cast by this process.

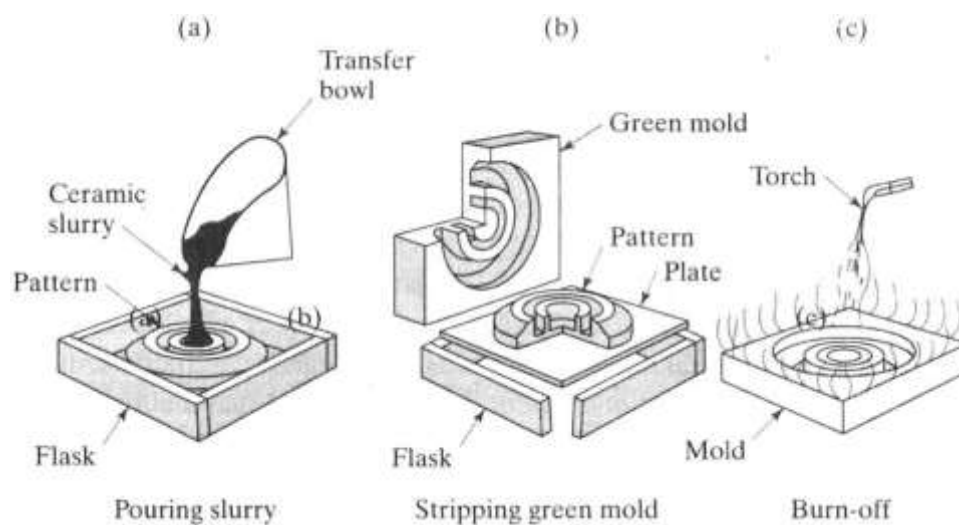

INVESTMENT CASTING

The investment-casting process is also known as *lost-wax process*. The pattern is made of wax or of a plastic (such as polystyrene) by molding or rapid prototyping techniques. The sequences involved in investment casting are shown in Fig. 1.10. The pattern is made by injecting molten wax or plastic into a metal die in the shape of the pattern. The pattern is then dipped into a slurry of refractory material such as very fine silica and binders, including water, ethyl silicate, and acids. After this initial coating has dried, the pattern is coated repeatedly to increase its thickness.

The term investment derives from the fact that the pattern is invested with the refractory material. Wax patterns require careful handling because they are not strong enough to withstand the forces involved during mold making. However, unlike plastic patterns, wax can be recovered and reused.

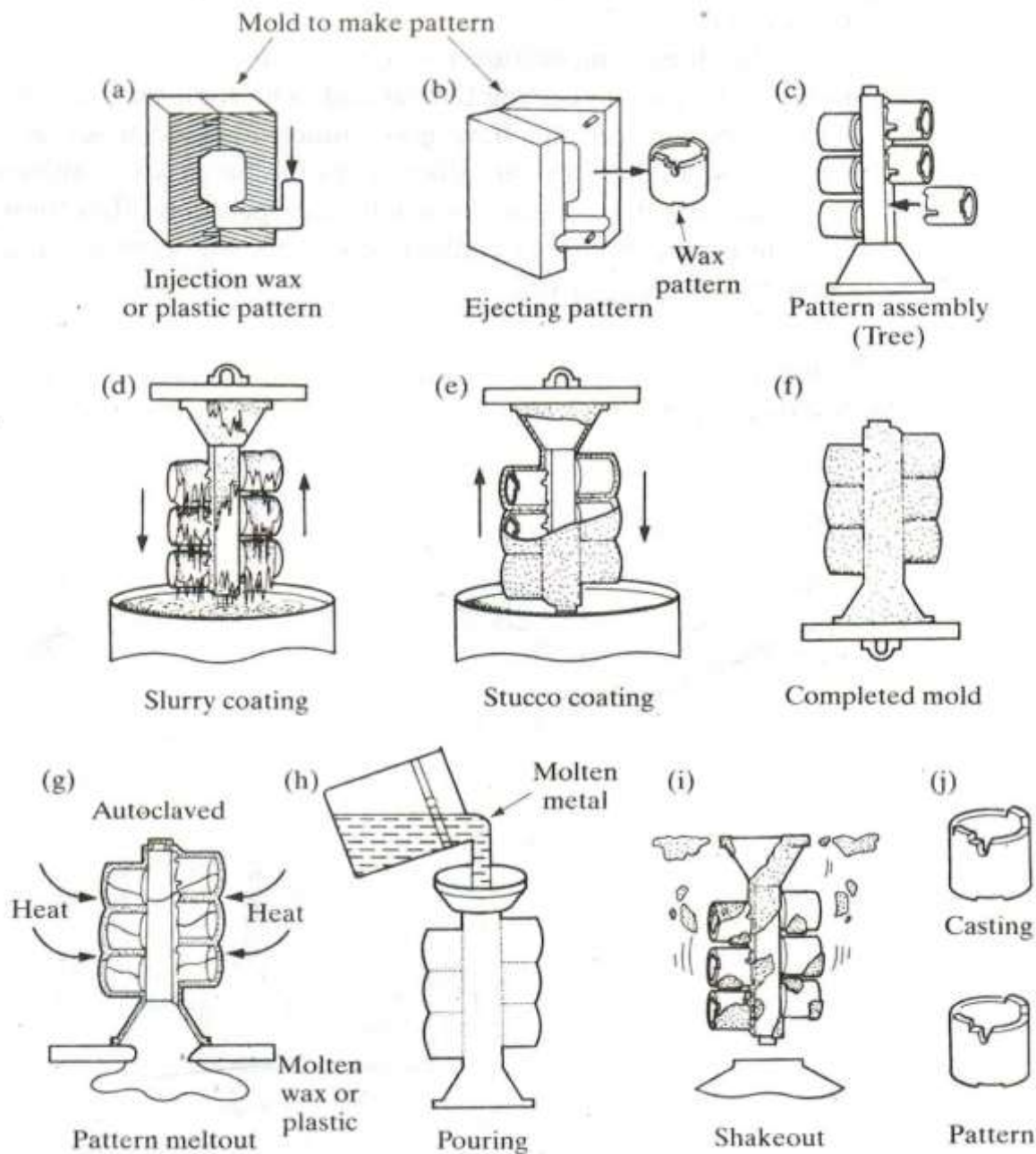

Schematic illustration of Investment Casting (Lost-wax process)

The one-piece mold is dried in air and heated to a temperature of $90^{\circ}\text{C} - 175^{\circ}\text{C}$. It is held in an inverted position for about 12 hours to melt out the wax. The mold is then fired to $650^{\circ}\text{C} - 1050^{\circ}\text{C}$ for about 4 hours, depending on the metal to be cast, to drive off the water of crystallization (chemically combined water) and burn off any residual wax. After the metal has been poured and has solidified, the mold is broken up and the casting is removed. A number of patterns can be joined to make one mold, called a tree (Fig. 1.10c), significantly increasing the production rate.

For small parts, the tree can be inserted into a permeable flask and filled with liquid slurry investment. The investment is then placed into a chamber and evacuated to remove air bubbles in it until the mold solidifies.

The flask is then treated as the mold shown in Fig. 1.10, except that it is commonly placed in a vacuum-casting machine, so that molten metal is drawn into the permeable mold and onto the part, producing fine detail.

Although the labor and materials involved make the lost-wax process costly, it is suitable for casting high-melting-point alloys with good surface finish and close dimensional tolerances. Therefore, few or no finishing

operations, which would otherwise add significantly to the total cost of the casting, are required.

This process is capable of producing intricate shapes, with parts weighing from 1g to 35 kg, from a wide variety of ferrous and nonferrous metals and alloys. Typical parts made are components for office equipment as well as mechanical components such as gears, cams, valves, and ratchets. Parts up to 1.5 m in diameter and weighing as much as 1140 kg have been successfully manufactured through this process.

VACUUM CASTING

It is also known as *counter-gravity low-pressure (CL) process*. A mixture of fine sand and urethane is molded over metal dies and cured with amine vapor. The mold is then held with a robot arm and partially immersed into molten metal held in an induction furnace.

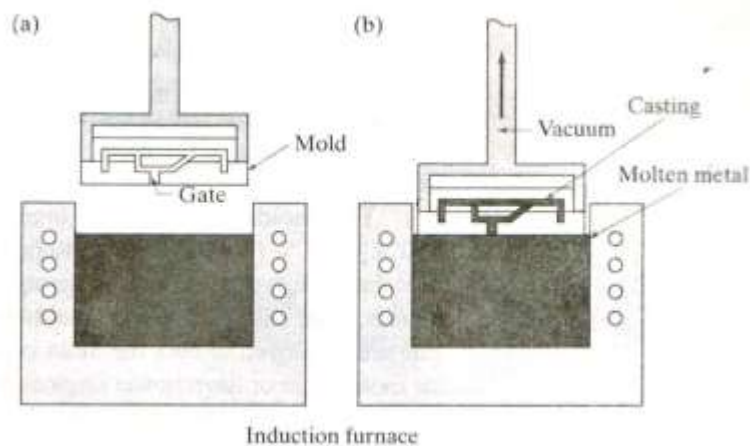

Fig 1.11: Schematic illustration of Vacuum Casting Process

(a) Before and (b) After immersion of the mold into the molten metal

The metal may be melted in air (CLA process) or in a vacuum (CLV process). The vacuum reduces the air pressure inside the mold to about two-thirds of atmospheric pressure, thus drawing the molten metal into the mold cavities through a gate in the bottom of the mold. The molten metal in the furnace is at a temperature usually 55°C above the liquidus temperature. Consequently, it begins to solidify within a fraction of a second. After the mold is filled, it is withdrawn from the molten metal.

This process is an alternative to investment, shell-mold, and green-sand casting, and is particularly suitable for thin-walled (0.75 mm) complex shapes with uniform properties. Carbon, low- and high-alloy steel, and stainless steel parts weighing as much as 70 kg have been vacuum cast by this method.

CLA parts are easily made at high volume and relatively low cost. CLV parts usually involve reactive metals, such as aluminum, titanium, zirconium, and hafnium. These parts, which are often in the form of super alloys for gas turbines, may have walls as thin as 0.5 mm. The process can be automated and production costs are similar to those for green-sand casting.

SLUSH CASTING

It was noted that a solidified skin develops first in a casting and that this skin then becomes thicker with time. Hollow castings with thin walls can be made by permanent mold casting using this principle; a process called slush casting. The molten metal is poured into the metal mold; after the desired thickness of solidified skin is obtained, the mold is inverted or slung, and the remaining liquid metal is poured out. The mold halves are

then opened and the casting is removed. Slush casting is suitable for small production runs and is generally used for making ornamental and decorative objects (such as lamp bases and stems) and toys from low melting point metals such as zinc, tin, and lead alloys.

PRESSURE CASTING

In the pressure-casting process, also called *pressure pouring* or *low pressure casting* (Fig. 1.12 a), the molten metal is forced upward by gas pressure into a graphite or metal mold. The pressure is maintained until the metal has completely solidified in the mold. The molten metal may also be forced upward by a vacuum, which also remove dissolved gases and produces a casting with lower porosity.

Pressure casting is generally used for high-quality castings-for example, steel railroad-car wheels. These wheels may also be cast in sand molds or semi permanent mold made of graphite and sand (Fig. 1.12 b).

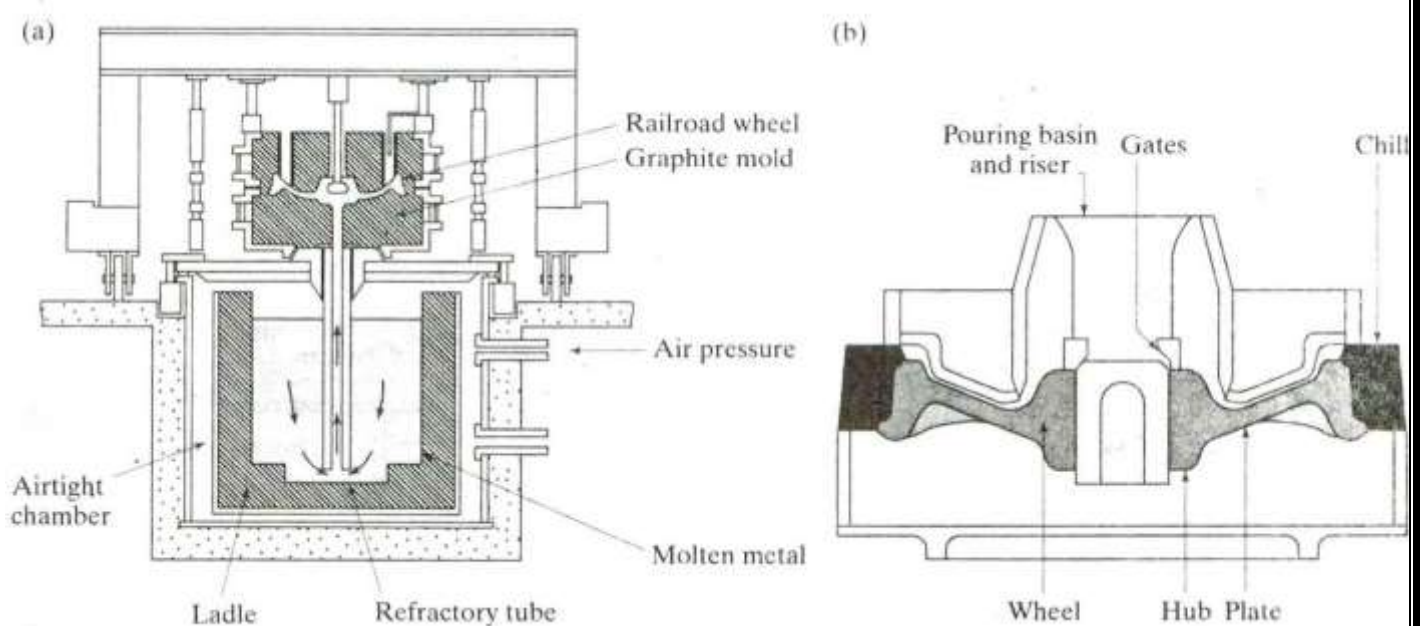

Fig. 1.12: (a) The bottom-pressure casting process utilizes graphite molds for the production of steel railroad wheels. (b) Gravity-pouring method of casting a railroad wheel.

DIE CASTING

The die-casting process is an example of permanent- mold casting. The molten metal is forced into the die cavity at pressures ranging from 0.7 MPa - 700 MPa.

Typical parts made through die casting are motors, business-machine and appliance components, hand tools, and toys. The weight of most castings ranges from less than 90 g to about 25 kg. There are two basic types of die-casting machines:

1. Hot-chamber and
2. Cold-chamber.

Hot-Chamber Process

The hot-chamber process (Fig. 1.13) involves the use of a piston, which traps a certain volume of molten metal and forces it into the die cavity through a gooseneck and nozzle. Pressures range up to 35 MPa, with an

average of about 15 MPa. The metal is held under pressure until it solidifies in the die. To improve die life and to aid in rapid metal cooling (thereby reducing cycle time) dies are usually cooled by circulating water or oil through various passageways in the die block.

Cycle times usually range up to 200-300 shots (individual injections) per hour for zinc, although very small components such as zipper teeth can be cast at 18,000 shots per hour. Low melting point alloys such as zinc, magnesium, tin, and lead are commonly cast using this process.

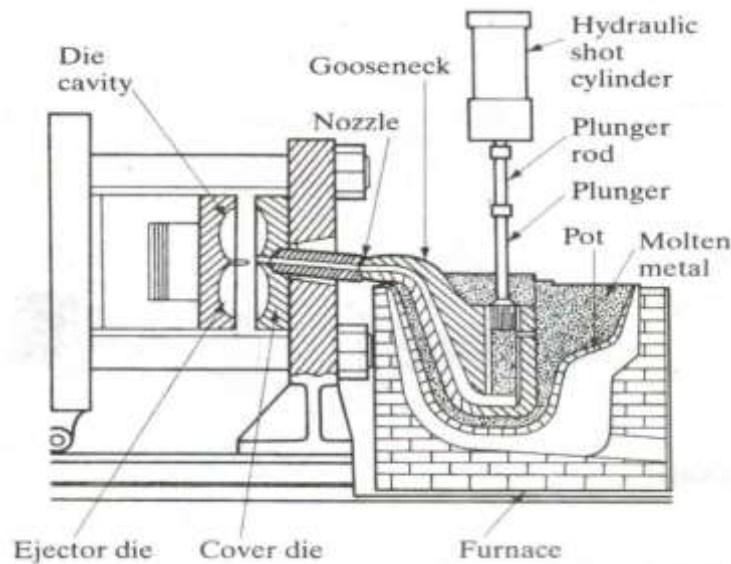

Fig. 1.13: Schematic illustration of the hot-chamber die-casting process

Cold-Chamber Process

In the cold-chamber process (Fig. 1.14), molten metal is poured into the injection cylinder (shot chamber). The shot chamber is not heated, hence the term cold chamber. The metal is forced into the die cavity at pressures usually ranging from 20 MPa to 70 MPa, although they may be as high as 50 MPa. The machines may be horizontal or vertical, in which case the shot chamber is vertical and the machine is similar to a vertical press.

High-melting-point alloys of aluminum, magnesium, and copper are normally cast using this method, although other metals (including ferrous metals) can also be cast in this manner. Molten-metal temperatures

start at about 600 °C for aluminum and some magnesium alloys, and increase considerably for copper-based and iron-based alloys.

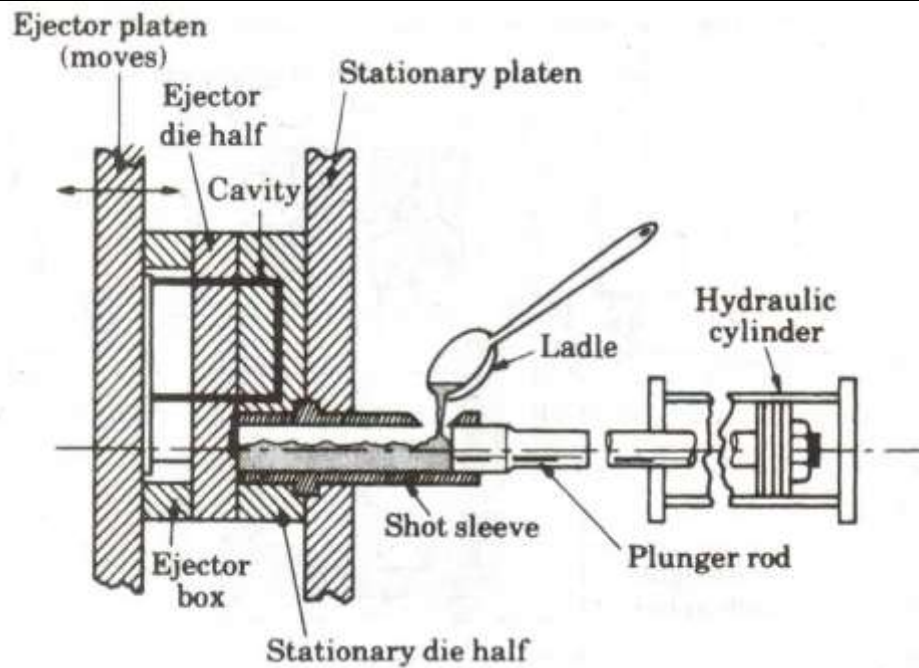

Fig. 1.14: Schematic illustration of the cold-chamber die-casting process

CENTRIFUGAL CASTING

As its name implies, the centrifugal-casting process utilizes the inertial forces caused by rotation to distribute the molten metal into the mold cavities. There are three types of centrifugal casting:

1. True centrifugal casting
2. Semi centrifugal casting, and
3. Centrifuging.

True Centrifugal Casting

In true centrifugal casting, hollow cylindrical parts, such as pipes, gun barrels, and streetlamp posts, are produced by the technique shown in Fig.1.15, in which molten metal is poured into a rotating mold. The axis of rotation is usually horizontal but can be vertical for short work pieces. Molds are made of steel, iron, or graphite, and may be coated with a refractory lining to increase mold life.

The mold surfaces can be shaped so that pipes with various outer shapes, including square or polygonal, can be cast. The inner surface of the casting remains cylindrical because the molten metal is uniformly distributed by centrifugal forces.

However, because of density differences, lighter elements such as dross, impurities, and pieces of the refractory lining tend to collect on the inner surface of the casting.

Cylindrical parts ranging from 13 mm to 3 m in diameter and 16 m long can be cast centrifugally, with wall thicknesses ranging from 6 mm to 125 mm. The pressure generated by the centrifugal force is very high and such high pressure is necessary for casting thick-walled parts.

Castings of good quality, dimensional accuracy, and external surface detail are obtained by this process. In addition to pipes, typical parts made are bushings, engine cylinder liners, and bearing rings with or without flanges.

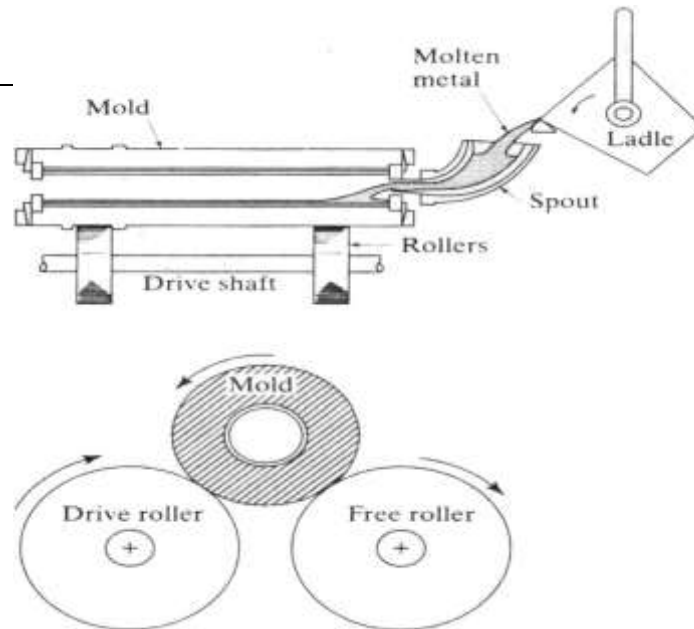

Fig. 1.15: Schematic illustration of the centrifugal casting process

Semicentrifugal Casting

An example of semicentrifugal casting is shown in Fig. 1.16. This method is used to cast parts with rotational symmetry such as a wheel with spokes.

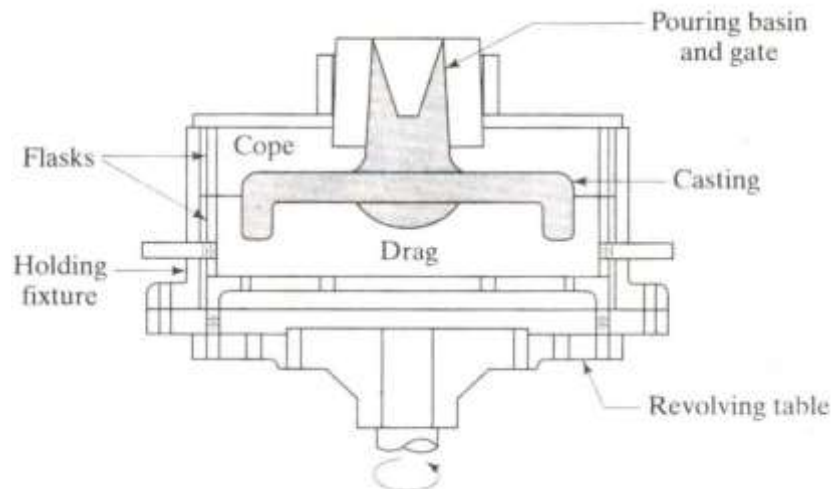

Fig. 1.16: Schematic illustration of the semicentrifugal casting process.

Centrifuging

In centrifuging, also called centrifuge casting, mold cavities of any shape are placed at a certain distance from the axis of rotation. The molten metal is poured from the center and is forced into the mold by centrifugal forces (Fig. 1.17). The properties of castings vary by distance from the axis of rotation.

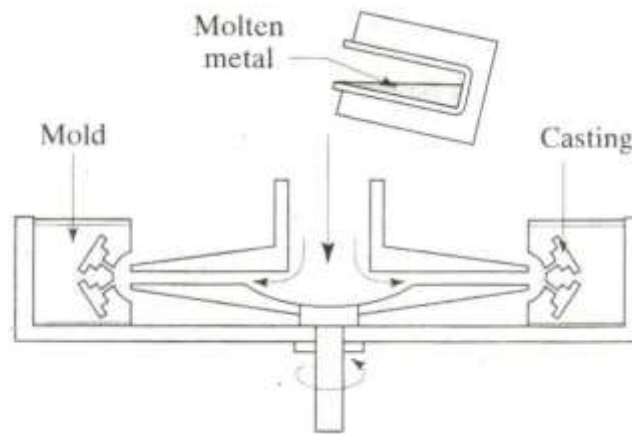

Fig. 1.17: Schematic illustration of casting by centrifuging

DEFECTS IN CASTINGS

The defects in a casting may arise due to the defects in one or more of the following:

1. Design of casting and pattern.
2. Moulding sand and design of mould and core.
3. Metal composition.
4. Melting and pouring.
5. Gating and risering.

The following defects are most commonly encountered in the sand mould castings

Blow

It is a fairly large, well-rounded cavity produced by the gases which displace the molten metal at the cope surface of a casting. Blows usually occur on a convex casting surface and can be avoided by having a proper venting and an adequate permeability. A controlled content of moisture and volatile constituents in the sand-mix also helps in avoiding the blow holes.

Scar

A shallow blow, usually found on a flat casting surface, is referred to as a scar.

Blister

This is a scar covered by the thin layers of a metal.

Gas holes

These refer to the entrapped gas bubbles having a nearly spherical shape, and occur when an excessive amount of gases is dissolved in the liquid metal.

Pin holes

These are nothing but tiny blow holes, and occur either at or just below the casting surface. Normally, these are found in large numbers and are almost uniformly distributed in the entire casting surface.

Porosity

This indicates very small holes uniformly dispersed throughout a casting. It arises when there is a decrease in gas solubility during solidification.

Drop

An irregularly-shaped projection on the cope surface of a casting is called a drop. This is caused by dropping of sand from the cope or other overhanging projections into the mould. An adequate strength of the sand and the use of gagers can help in avoiding the drops.

Inclusion

It refers to a nonmetallic particle in the metal matrix. It becomes highly undesirable when segregated.

Dross

Lighter impurities appearing on the top surface of a casting are called dross. It can be taken care of at the pouring stage by using items such as a strainer and a skim bob.

Dirt

Sometimes sand particles dropping out of the cope get embedded on the top surface of a casting. When removed, these leave small, angular holes, known as dirt. Defects such as drop and dirt suggest that a well-designed pattern should have as little a part as possible in the cope. Also, the most critical surface should be placed in the drag.

Wash

A low projection on the drag surface of a casting commencing near the gate is called a wash. This is caused by the erosion of sand due to the high velocity jet of liquid metal in bottom gating.

Buckle

This refers to a long, fairly shallow, broad, vee-shaped depression occurring in the surface of a flat casting of a high temperature metal. At this high temperature, an expansion of the thin layer of sand at the mould face takes place before the liquid metal at the mould face solidifies. As this expansion is obstructed by the flask, the mould face tends to bulge out, forming the vee shape. A proper amount of volatile additives in the sand-mix is therefore essential to make room for this expansion and to avoid the buckles.

Scab

This refers to the rough, thin layer of a metal, protruding above the casting surface, on top of a thin layer of sand. The layer is held on to the casting by a metal stringer through the sand. A scab results when the upheaved sand is separated from the mould surface and the liquid metal flows into the space between the mould and the displaced sand.

Rat tail

It is a long, shallow, angular depression normally found in a thin casting. The reason for its formation is the same as that for a buckle. Here, instead of the expanding sand upheaving, the compressed layer fails by one layer, gliding over the other.

Penetration

If the mould surface is too soft and porous, the liquid metal may flow between the sand particles up to a distance, into the mould. This causes rough, porous projections and this defect is called penetration. The fusion of sand on a casting surface produces a rough, glossy appearance.

Swell

This defect is found on the vertical surfaces of a casting if the moulding sand is deformed by the hydrostatic pressure caused by the high moisture content in the sand.

Misrun

Many a time, the liquid metal may, due to insufficient superheat, start freezing before reaching the farthest point of the mould cavity. The defect that thus results is termed as a misrun.

Cold shut

For a casting with gates at its two sides, the misrun may show up at the centre of the casting. When this happens, the defect is called a cold shut.

Hot tear

A crack that develops in a casting due to high residual stresses is called a hot tear.

Shrinkage cavity

An improper riser may give rise to a defect called shrinkage cavity.

Shift

A misalignment between two halves of a mould or of a core may give rise to a defective casting, as shown in Fig 1.18. Accordingly, this defect is called a mould shift or a core shift.

METAL FORMING

Metal forming is a process in which shape of the metals are changed to desired shapes by subjecting them to stresses greater than yield stress of the metal. Metal forming can be classified into two:

Plastic deformation process (Primary process)

In plastic deformation process, the volume and mass of the metals are unchanged. eg. rolling, forging, extrusion, etc.

Metal removal or machining process (Secondary process)

In machining process, the material is removed from the metal. eg. turning, thread cutting, etc.

Mechanical working of metals is needed for the following purposes.

- 1) To reduce original block or ingot to the finished dimensions of the part, saving material machining cost and time.
- 2) To improve the mechanical properties of the metals.
- 3) Refinement of grain structure.
- 4) Removing defects such as blow holes, etc., from the metal.

In metal forming processes, the metal being processed is plastically deformed to shape it into a desired geometry. In order to plastically deform a metal, a force must be applied that will exceed the yield strength of the material. When low amounts of stress are applied to a metal it will change its geometry slightly, in correspondence to the force that is exerted. Basically it will compress, stretch, and/or bend a small amount. The magnitude of the amount will be directly proportional to the force applied. Also the material will return to its original geometry once the force is released. Think of stretching a rubber band, then releasing it, and having it go back to its original shape. This is called elastic deformation. Once the stress on a metal increases past a certain point, it no longer deforms elastically, but starts to undergo plastic deformation. In plastic deformation, the geometric change in the material is no longer directly proportional to stress and geometric changes remain after the stress is released; meaning that the material does not recover its shape. The actual level of stress applied to a metal where elastic deformation turns to plastic deformation is called the proportional limit, and is often difficult to determine exactly. The 0.002 offset convention is usually used to determine the yield point, which is taken for practical purposes as the stress level where plastic deformation, (yielding), begins to occur.

It can be seen by the stress-strain graph that once the yield point of a metal is reached and it is deforming plastically, higher levels of stress are needed to continue its deformation. The metal actually gets stronger, the

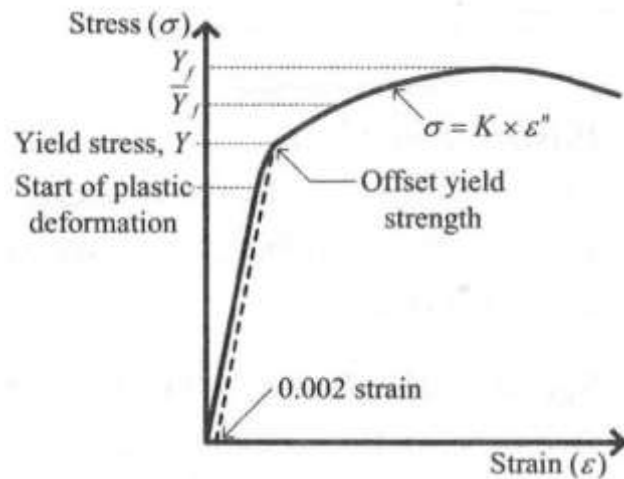

more it is deformed plastically (strain hardening).

Stress-strain diagram for a typical metal

For some metalworking calculations (eg. forging), the flow stress Y_f of the work material (instantaneous value of the force necessary to continue the yielding and flow of the work material at any point during the process) must be known.

The maximum flow stress may be a critical measurement in some metal forming operations, since it will specify the force and power requirements for the machinery to perform the process. For a process like forging, the maximum flow stress value would be very important. However, for a process like extrusion, where the metal is continuously being deformed and the different stages of the metal's deformation are occurring simultaneously, it is of interest to analyze the mean flow stress value. In some cases, analysis is based not on the instantaneous flow stress, but on an average value over the strain-stress curve from the beginning of strain to the final (maximum) value that occurs during deformation. The mean flow stress is expressed below.

ROLLING

The process of plastically deforming metal by passing it between rolls is known as rolling. Rolling is a forming operation where cylindrical rolls are used to reduce the cross sectional area of a bar or plate with a corresponding increase in the length. In this process, the work is subjected to high compressive stresses from the squeezing action of rolls and to surface shear stresses as a result of the friction between the rolls and the metal. Also, the frictional forces help for drawing the metal into the rolls. Purpose of rolling is to convert large sections such as ingots into smaller sections. Rolling helps to improve various physical properties such as strength, toughness, ductility and shock resistance. A large number of useful articles such as sheets, rails, plates, rings, bars, etc., are produced through rolling. The rolling process can be hot rolling or cold rolling based on their operating temperatures.

Hot rolling

Hot rolling is the process of rolling a metal above its recrystallization temperature. The first hot working operation for most steel products is done in the blooming mills. Blooming mills are usually high reversing mills, with forged rolls each weighing up to 20 tones. They are driven by a reversing electric motor of up to 20 MW capacities. As a result of squeezing, the grains are elongated in the direction of rolling and after crossing the stress zone, grains start refining. The figure shows the changes in the grain structure of hot

rolling. Hot rolling is an effective way to reduce grain size in metals for improved strength and ductility. Cast structures of ingots or continuous castings are converted to a wrought structure by hot working.

In hot steel rolling, the continuous exposure of metal to air produces a layer of oxide called as scale is formed on the surface of the steel. The layer of scale separates the work roll from the metal substrate. The formation of scale is influenced by the temperature of stock being heated, the composition of the steel, the furnace atmosphere (whether excess air or not), etc. Formation of scale means loss of valuable steel metal. Generally, it is around 1% of the input weight.

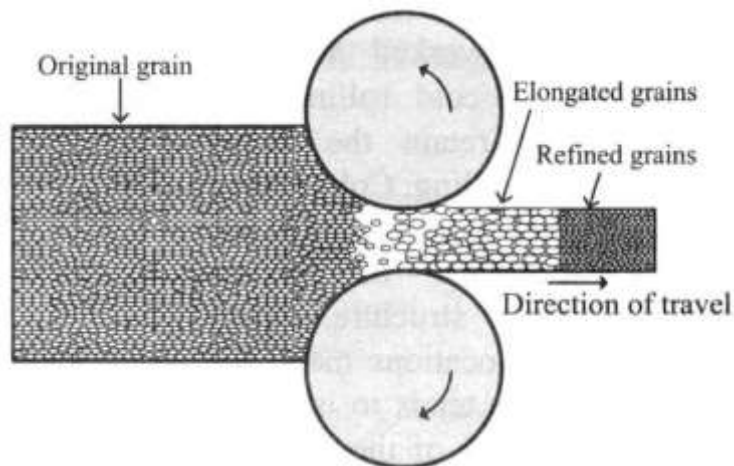

Recrystallisation temperature is very important from the point of view of mechanical working of metals. When a metal is heated and deformed under mechanical force, an energy level will be reached when the old grain structure starts disintegrating. Simultaneously, an entirely new grain structure (equi-axed, stress free) with reduced grain size starts forming. This phenomenon is known as 'recrystallisation' and the temperature at which this phenomenon starts is called 'recrystallisation temperature'. It takes some time for this phenomenon to get completed. According to ASM (American Society of Metals), the recrystallisation temperature is defined as 'the approximate minimum temperature at which the complete recrystallisation of a cold worked metal occurs within a specified period of approximately one hour. Recrystallisation decreases the strength and raises the ductility of the metal.

Advantages of Hot Rolling

- 1) Hot rolling brings homogeneity in rolled components.
- 2) Grain refinement gives optimum mechanical properties to the alloy.
- 3) Time taken to produce the component is less compared to cold rolling.

Disadvantages of hot rolling

- 1) Chance of scale inclusion exists.
- 2) Surface oxidation takes place.
- 3) Process is more expensive.

Cold rolling

Cold rolling is a process of rolling metals and alloys below their recrystallization temperatures. Generally it is worked at room temperatures. In cold rolling, the grains tend to retain the shape acquired during rolling. Cold rolling being a cold working process, produces additional dislocations within the metal structure. When two or more dislocations meet, the movement of one tends to interfere with the movement of the other. As the working continues, however, the movement of the dislocations becomes more difficult. This increases the strength of the metal and also makes it stiffer. Therefore the metal becomes less ductile more brittle and this

feature is called as work hardening or strain hardening. As such, the metal must be heated from time to time (annealed) during the rolling operation to remove the undesirable effects of cold working and to increase the workability of the metal.

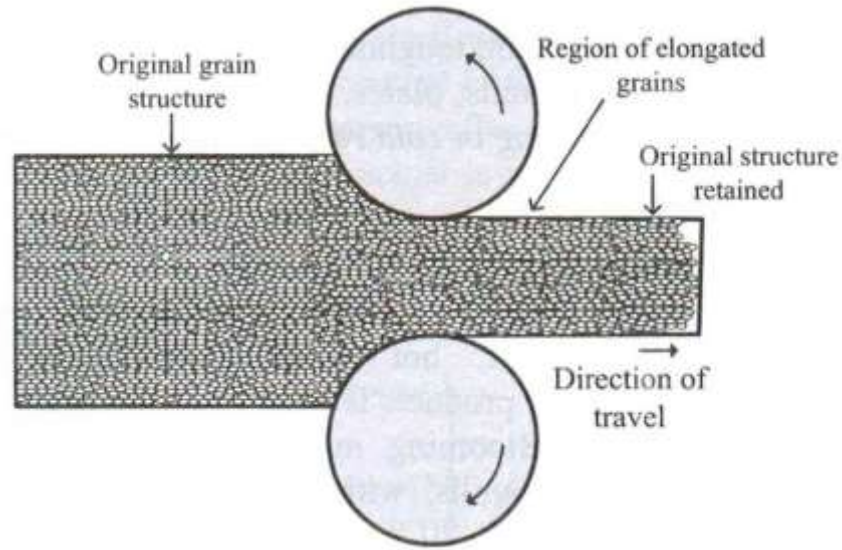

Fig 2.3: Cold rolling

Advantages of cold rolling

- 1) Cold rolling is used to produce sheets and strips of fine surface finish and accuracy.
- 2) Strength of cold rolling will be high because of strain hardening.
- 3) Close dimensional tolerances can be achieved.
- 4) Reduced defects.

Disadvantages of cold rolling

- 1) Internal stresses are induced into the cold worked metal thus making the metal hard and brittle.

Comparison between hot working and cold working

S No.	Hot Working	Cold Working
1	Metal heated above its recrystallization temperature.	Metal heated below its recrystallization temperature.
2	Being carried out at recrystallization temperature, there is no strain hardening	No recrystallization leading to strain hardening (work hardening).
3	Co-efficient of friction between rolls and work is higher.	Lesser.
4	Heavy reduction in area can be obtained.	Heavy reduction in area cannot be obtained.
5	Mechanical properties are improved. Less decrease in ductility.	Hardness increases. Brittleness increases. Ductility decreases.
6	Blow-holes and other similar defects are removed.	Excessive cold rolling generates cracks.
7	Roll radius is generally larger.	Smaller.

8	Hot rolling sheets less than 1.25 mm is not economical.	Thin sections can be obtained. (0.002 mm)
9	Hot rolling has scale (metal oxide) on it.	Oxide free.
10	Surface finish is not good.	Good surface finish is obtained.
11	Residual stresses are less.	More due to deformation of crystals and work hardening effect.

Types of rolling mills

Rolling mills can be conveniently classified with respect to the number and arrangement of the rolls as follows.

Two high mill

This is the simplest and most common type of rolling. These are further classified as reversing and non reversing mills. In non reversing mills, rolls of equal size are rotated only in one direction. In two high reversing mills, the work can be passed to and fro through the rolls by reversing their direction of rotation. The space between the rolls can be adjusted by raising or lowering the upper roll. Two high mills are used for breaking down of ingots.

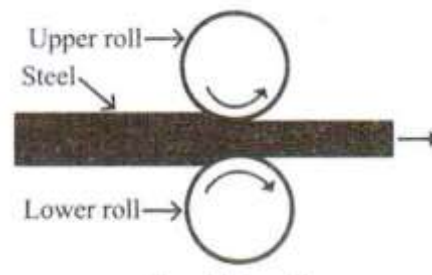

Fig 2.4: Two high mill

Three high mill

This consists of three rolls of equal size one above the other. The upper and lower rolls are power driven, while the middle roll rotates by friction. The direction of upper and lower rolls is the same. It is used for the production of steel shapes such as I-beams, angles, channels, etc.

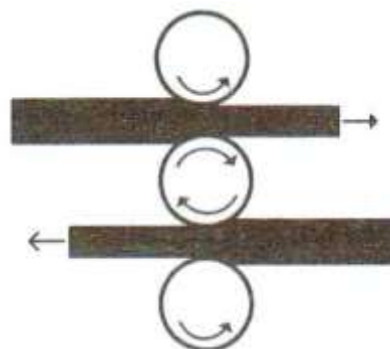

Fig 2.5: Three high mill

Four high mill

This consists of two small diameter working rolls and two large diameter backup rolls placed one above the other. Function of backup rolls is to prevent the deflection of small rolls. Function of working rolls concentrate the total rolling pressure over the work-piece. Less power is needed as less friction due to less contact area. The common products of these mills are hot or cold rolled plates and sheets.

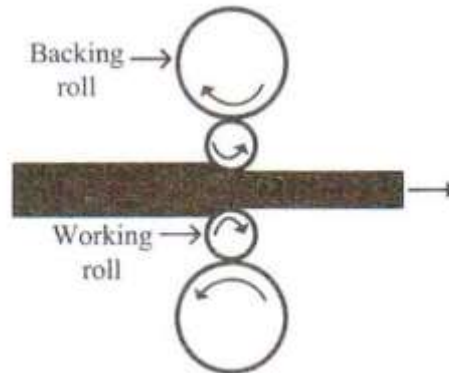

Fig 2.6: Four high mill

Cluster mill

Each of the work rolls (power driven) are supported by two backing rolls for support. For rolling hard thin materials, it may be necessary to employ work rolls of very small diameter but of considerable length. In such cases adequate support of the working rolls can be obtained by using a cluster-mill. This type of mill is generally used for cold rolling work.

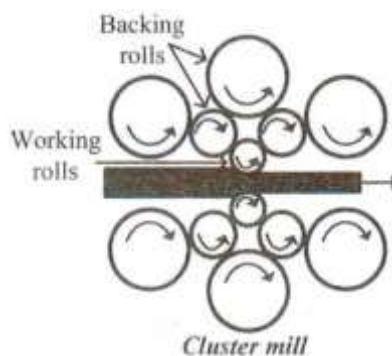

Fig 2.7: Cluster mill

Tandem mill

In this, a series of rolling mills are after the other, to facilitate high production each stand. Each set of rolls is called stand. Since different reduction takes place at each stand, the strip will be moving at different velocities.

Although only five stands are shown in our sketch, a typical tandem rolling mill may have eight or ten stands,

each making a reduction in thickness or a refinement in shape of the work passing through. With each rolling step, work velocity increases, and the problem of synchronizing the roll speeds at each stand is critical. Front tension (tension at the exit of strip) and back tension (tension at the entry of the strip) may be applied by suitable means (not shown in the figure) to reduce the rolling force.

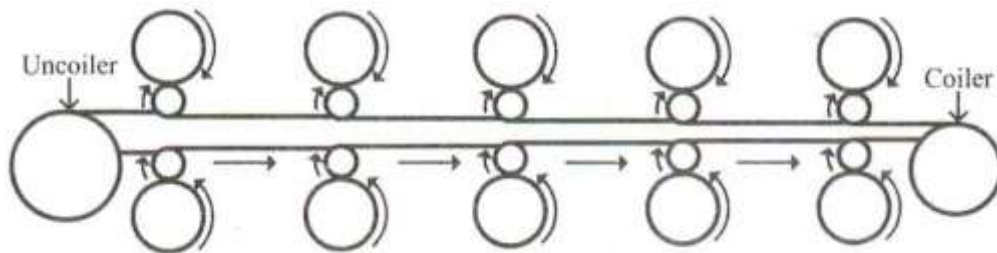

Fig 2.8: Tandem mill

Steckel mill

Steckel mill-is similar to tandem mill except for no working roll is power driven. Only the un-coiler and the wind up reels are power driven. In this mill, amount of reduction is limited. But hard steels can be reduced to thin sections with close tolerances. Steckel mills are called reversible finishing mills because the rollers on the machine can be set to roll both forward and backward over the raw material.

Planetary rolling mills

The planetary rolling mills consist of two heavy and large backing rolls surrounded by small diameter planetary rolls. The strip to be rolled is fed forward with the help of feed rolls. The rolling force is conveyed more effectively by small diameter rolls because of reduced area of contact of smaller rolls, which produce higher rolling pressures. Each pair of roll bites the red hot metal successively, extending the metal strip into length and reducing in thickness. Each pair of planetary rolls gives an almost constant reduction to the slab. The main feature of this mill is that it hot reduces a slab to coiled strip in a single pass. The planetary rolling mills are capable of bringing thickness reduction of 25:1 as against 2:1 in conventional rolling mills.

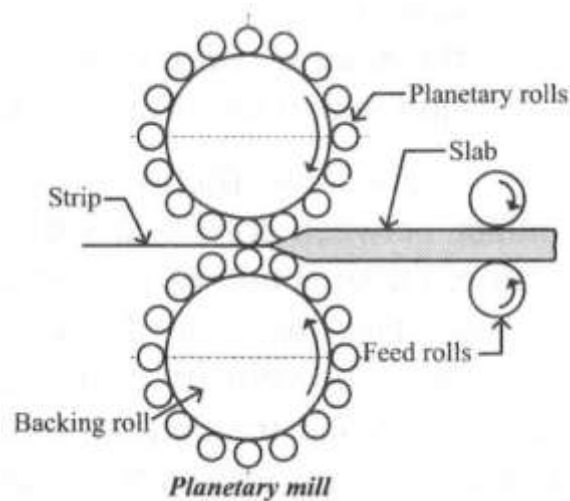

Fig 2.9: Planetary rolling mill

MECHANICS OF FLAT ROLLING

The basic flat-rolling process is shown schematically in the figure. A strip of thickness h_o enters the roll gap and is reduced to a thickness of h_f by the powered rotating rolls at a surface speed V_r of the roll. To keep the volume rate of metal flow constant, the velocity of the strip must increase as it moves through the roll gap, as is the case with incompressible fluid flow through a converging channel. At the exit of the roll gap, the velocity of the strip is V_f . Since V_r is constant along the roll gap, but the strip velocity increases as it passes through the roll gap, sliding occurs between the roll and the strip. The strip is reduced in thickness to h_f with width of the strip is assumed to remain constant during rolling.

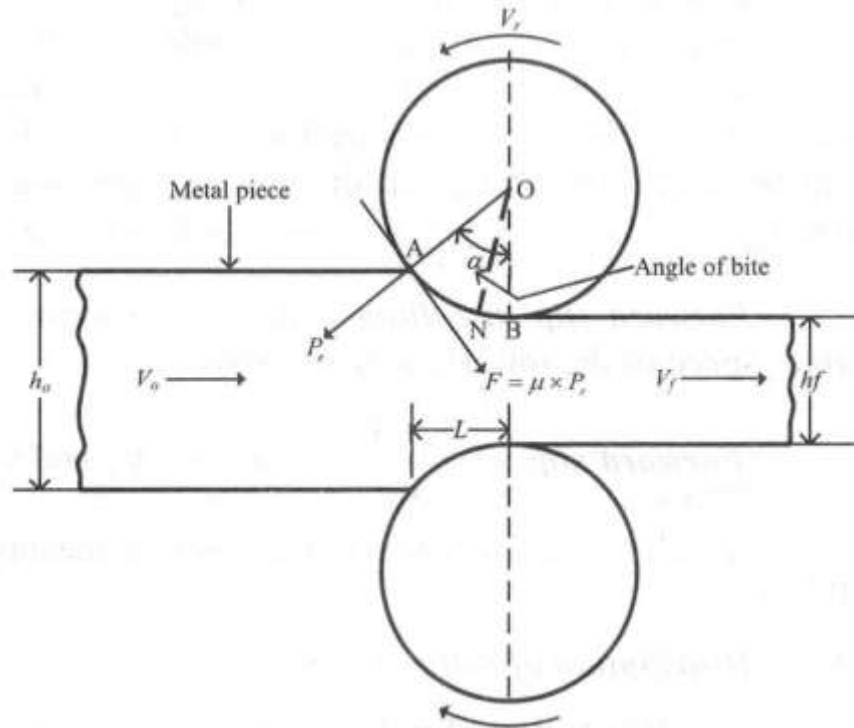

Fig 2.10: Mechanics of flat rolling

Rolling basically consists of passing the metal piece through two rolls rotating in opposite directions. The space between the rolls is adjusted to the desired thickness of the rolled section. Each of the two rolls contacts

the metal surface along the arc AB, which is called **arc of contact**. The angle AOB is called **angle of contact** or the **angle of bite**. The friction between metal piece and rolls provide sufficient grip for the rolls to move the metal piece through the rolls. The reduction in thickness increases with coefficient of friction. **Length of contact** (L) is the horizontal projection of the arc of contact between the rolled piece and the rollers. Since the surface speed of the roll is constant, there is relative sliding between the roll and the strip along the arc of contact in the roll gap. At one point along the contact length, the velocity of the strip is the same as that of the roll. This is called the **neutral point**, or **no slip point**. To the left of this point, the roll moves faster than the strip, and to the right of this point, the strip moves faster than the roll.

In rolling, frictional force acts tangential to the rolls at any section along the arc of contact between rolls and strip. Between the entry section of the roll gap and the neutral section, the direction of friction is the same as the direction of motion of the strip i.e., into the roll gap. The direction of friction reverses after the neutral point, as the velocity of strip is higher than the velocity of the rolls. Friction force opposes the forward motion of the strip in sections beyond the neutral section. However, the magnitude of the friction acting ahead of neutral section is greater than that beyond the neutral section. The frictional force on the left of the neutral point must be greater than the frictional force on the right. This difference yields a net frictional force to the right, which makes the rolling operation possible by pulling the strip into the roll gap. Furthermore, the net frictional force and the surface velocity of the roll must be in the same direction in order to supply work to the

system. Therefore, the neutral point should be located toward the exit in order to satisfy these requirements. For plane strain rolling, the width w of the strip is assumed to be constant i.e., the vertical compression of the metal is translated into an elongation. Since there is no change in metal volume at a given point per unit time throughout the process, applying the principle of volume constancy.

PRESSURE

The distribution of roll pressure along the arc of contact shows that the pressure rises to a maximum at the neutral point and then falls off. The pressure distribution does not come to a sharp peak at the neutral point, which indicates that the neutral point is not really a line on the roll surface but an area.

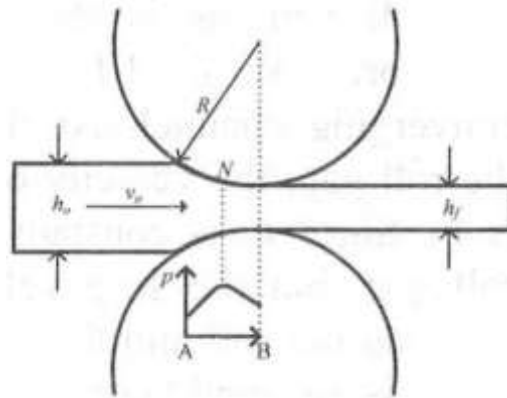

Fig 2.11: Distribution of pressure in flat rolling

FRONT AND BACK TENSIONS

The roll force, F , can be reduced by various means, such as using rolls of smaller radii, taking smaller reductions, and raising work-piece temperature. An effective method is to reduce the apparent compressive yield stress of the material by applying longitudinal tension. Another method of reducing rolling force is to apply a small tensile force on the strip. If tension is applied to a strip, the yield stress normal to the strip surface drops, and hence the roll pressure will decrease.

Tensions in rolling can be applied either at the entry (**back tension, σ_b**) or at the exit (**front tension, σ_f**) of the strip or at both. As a result of application of front tension or back tension, the neutral point is shifted forward or backward. Front tension leads to shift of the neutral point forward, whereas, application of back tension shifts the neutral point backward. Application of both forward and back tensions reduces the total roll force. Hence, the torque and power for rolling get reduced. The figure above exhibits the effects of front and back tension on rolling pressure.

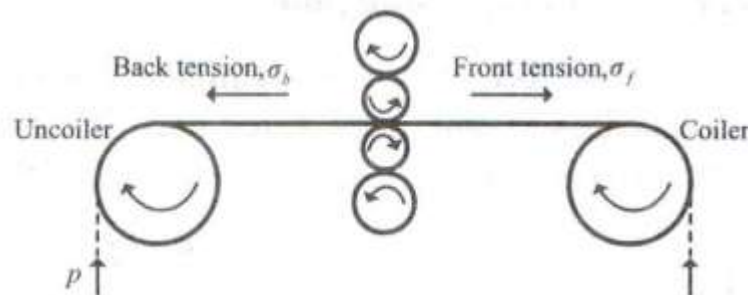

Fig 2.11: Back tension and front tension in rolling

ROLLFORCES

At any point along the surface of contact between the roll and the sheet, two forces act on the metal viz., a radial force, P_r and a tangential frictional force, F .

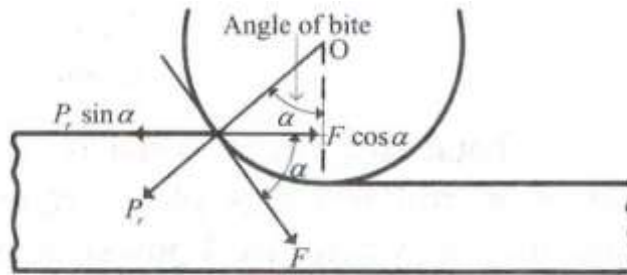

Fig 2.12: Roll forces

FRICTION IN ROLLING

In rolling, although the rolls cannot pull the strip into the roll gap without some friction, forces and power requirements rise with increasing friction. Coefficient of friction in rolling depends on lubrication, work material, and working temperature. In **cold rolling**, μ usually ranges between **0.02** and **0.3**, depending on the materials and lubricants used. In **hot rolling**, μ may range from about **0.2**, with effective lubrication, to as high as **0.7**. Hot rolling is often characterized by a condition called **sticking**, in which the hot work surface adheres to the rolls over the contact area. This condition often occurs in the rolling of steels and high-temperature alloys. The consequence of sticking is that the surface layers of the work are restricted to move at the same speed as the roll speed and below the surface, deformation is more severe in order to allow passage of the piece through the roll gap.

The maximum possible draft, i.e., $(h_o - h_f)$ in flat rolling is a function of friction and roll radius as given below.

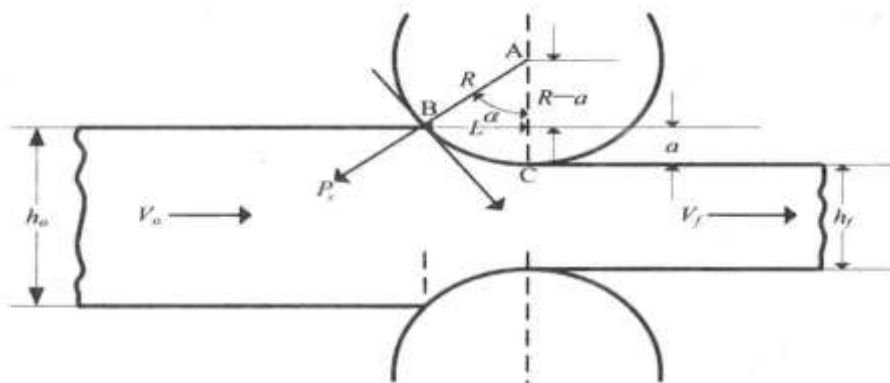

Fig 2.13: Determination of maximum possible draft in flat rolling

From the triangle ABC, we have,

$$R^2 = L^2 + (R - a)^2$$

$$L^2 = R^2 - (R - a)^2$$

$$L^2 = R^2 - R^2 + 2R \times a - a^2$$

$$L^2 = 2R \times a - a^2$$

ROLL DEFLECTION AND ROLL FLATTENING

Due to roll force, the rolls are subjected to deflection and they bend resulting in larger thickness at the centre of the rolled sheet and the edge being thinner. This widthwise difference in thickness is called the strip crown. In order to avoid this rolls are given a slight curvature on surface by grinding so that the centre of the rolls has higher diameter than the edges. This is called **cambering** of rolls. The bulged rolls, when subjected to bending during rolling will produce flat sheets. For sheet rolling, normally camber of 0.5 mm on roll diameter is provided. Also during hot rolling, rolls get heated up and bulge out at the center, causing rolls. This is due to temperature variation between edges and the center of rolls. This effect can be controlled by varying the location of coolant on the rolls.

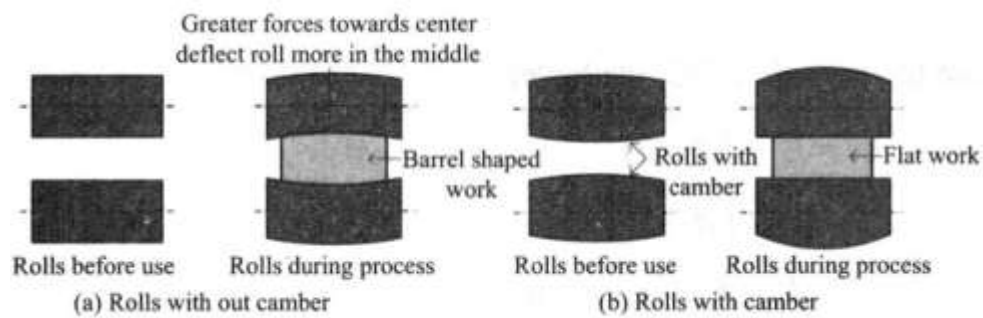

Fig 2.14: Roll deflections in flat rolling

The camber that must be ground into a roll is very specific to a particular work width, material, and force load. A roll must usually be manufactured for only one metal rolling process. In some industrial metal rolling processes, rolls are given temporary camber by applying forces through their bearings. Another way that rolls deflect is by the shortening of their radius along the contact of the work. Roll camber has to be varied during rolling in order to take care of roll camber due to both thermal effects and roll deflection. This also avoids uneven roll wear- rolls wear more at edges than at center.

Another way that rolls deflect is by the shortening of their radius along the contact of the work. In other words, they flatten like a tire on a car might. This increase in radius of curvature of rolls due to the roll pressure causes elastic deformation of rolls. This is known as roll flattening. Roll flattening leads to increase in contact length and hence an increase in roll force.

SPREAD

Spread refers to the increase in width of rolled strips. Spread is the flow of material at right angles to the directions compression and elongation. Spreading is much evident in strips having smaller width-to-thickness ratios, such as a square cross-section, the width increases considerably during rolling. The higher the coefficient of friction, higher is the resistance to lengthwise flow and more is the spread. Spreading decreases with increasing width-to-thickness ratios of the entering material, increasing friction and increasing ratios of

roll radius to strip thickness (lower frictional resistance in the rolling direction). Spreading can be prevented by using vertical rolls that are in contact with the edges of the rolled product

LUBRICATION IN ROLLING

In metal rolling processes, lubricants are applied to keep the surfaces of roll and workpiece separated by a film of solid or fluid. This serves two primary purposes. Firstly the lubricant will generally have a relatively low shear stress compared with the work-piece, so that the friction forces generated by shearing of the lubricant will be lower than by shearing of the work-piece itself. Lower loads will then be needed to deform the work-piece. So, lubrication reduces friction and as a consequence it reduces amount of electricity used reduces separating forces, reduces wear and improves the surface of rolled material. Secondly, damage to the surface of the work-piece will be reduced as the surfaces are kept apart. The lubricant may act as a coolant. In metal working, the heat generated by deformation work is often considerable and this role can be of crucial importance.

Ferrous alloys are usually hot rolled without a lubricant, although graphite may be used. Aqueous solutions are used to cool the rolls and break up the scale on the work-piece. Nonferrous alloys are hot rolled with a variety of compounded oils, emulsions, and fatty acids. Cold rolling is done with low-viscosity lubricants, including mineral oils, emulsions, paraffin, and fatty oils.

SHAPE ROLLING

An ingot or bloom need to be passed many times between different rolls before it is shaped into flat, round or section. Plates, sheets and strips are produced by rolling between smooth, cylindrical rolls. Bars, rods and sections are produced by passing the work between rolls having grooves cut in them. The shape formed when the grooves of mating rolls are matched together is called the pass. After being shaped in one pass, the stock is turned 90° about its axis before being entered into next pass. In addition to flat rolling, various shapes can also be produced by shape rolling. In shape rolling, the work is deformed into a contoured cross section. Products made by shape rolling include shapes such as I-beams, L-beams, and U-channels; rails for railroad tracks; and round and square bars and rods. The process is accomplished by passing the work through rolls that have the reverse of the desired shape.

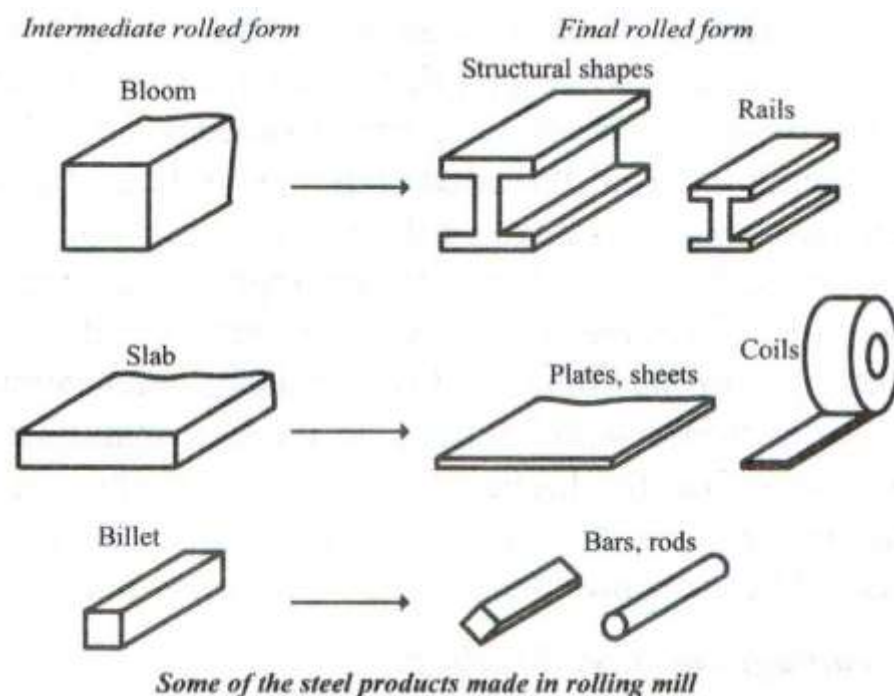

Fig 2.15: Some of the steel products made in rolling mill

Most of the principles that apply in flat rolling are also applicable to shape rolling. Shaping rolls are more complicated; and the work, usually starting as a square shape, requires a gradual transformation through several rolls in order to achieve the final cross section. Designing the sequence of intermediate shapes and corresponding rolls is called roll-pass design. Its goal is to achieve uniform deformation throughout the cross section in each reduction. Otherwise, certain portions of the work are reduced more than others, causing greater elongation in these sections. The consequence of non-uniform reduction can be warping and cracking of the rolled product. Both horizontal and vertical rolls are utilized to achieve consistent reduction of the work material.

Ring Rolling

Ring rolling is a deformation process in which a thick-walled ring of smaller diameter is rolled into a thin walled ring of larger diameter. The process of ring rolling is illustrated in the figure. As the thick-walled ring is compressed, the deformed material elongates, causing the diameter of the ring to be enlarged. Ring rolling is usually performed as a hot-working process for large rings and as a cold-working process for smaller rings. Applications of ring rolling include ball and roller bearing races, steel tyres for railroad wheels, and rings for pipes, pressure vessels, and rotating machinery. The ring-rolling process can be carried out at room or elevated temperature, depending on the size, strength, and ductility of the work-piece material. Compared to other manufacturing processes capable of making the same part, the advantages of this process are short production times, material savings, close tolerances, and favorable grain flow in the product.

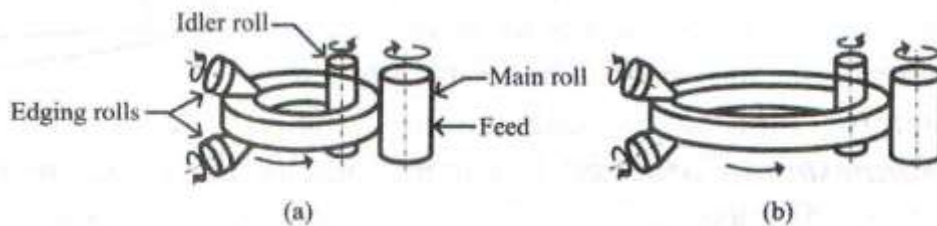

Fig 2.16: Ring rolling

Thread Rolling

Thread rolling is used to form threads on cylindrical parts by rolling them between two dies. It is the most important commercial process for mass producing external threaded components (e.g., bolts and screws). Most thread rolling operations are performed by cold working in thread rolling machines. These machines are equipped with special dies that determine the size and form of the thread. The dies are of two types viz., flat dies, which reciprocate relative to each other, as illustrated in the figure and round dies, which rotate relative to each other to accomplish the rolling action. Thread rolling, in modern manufacturing, has an extremely high productivity rate, significantly higher than producing threaded parts by machining. Machining is the alternative method to industrial manufacturing of threaded parts. Producing threads by this method has several other benefits over machining.

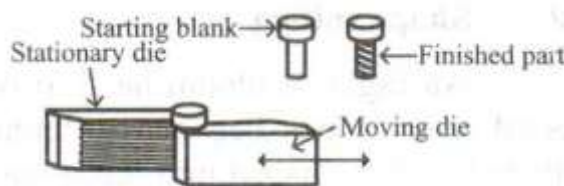

Fig 2.17: Thread Rolling

Advantages of thread rolling

- 1) Production rates in thread rolling is high.
- 2) Better fatigue resistance due to compressive stresses introduced by rolling.
- 3) Better material utilization.
- 4) Smoother surface.
- 5) Thread rolling is superior to other methods of thread manufacture, because machining the threads cuts through the grain-flow lines of the material, whereas rolling the threads results in a grain-flow pattern that improves the strength of the thread.

Rotary Tube Piercing

Rotary tube piercing, a hotworking process is used to make long, thick-walled seamless tubes. The process is based on the principle that when a round bar is subjected to radial compression, tensile stresses develop at the centre of the roll. When the rod is subjected to cycling compressive stresses, a cavity begins to form at the centre of the rod. The rotary-tube piercing process (called as the Mannesmann process) is carried out by an arrangement of rotating rolls, as shown in the figure. The axes of the rolls are skewed (tilted) in order to pull the round bar through the rolls by the longitudinal-force component of their rotary action. A mandrel assists the operation by expanding the hole and sizing the inside diameter of the tube. Because of the severe deformation that the metal undergoes in this process, high-quality, defect-free bars must be used.

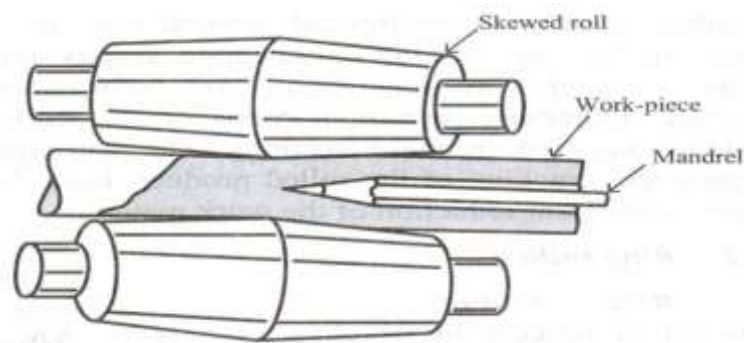

Fig 2.18: Rotary Tube Piercing

Tube rolling

The diameter and thickness of tubes and pipes that are produced by various process can be reduced by tube rolling using shaped rolls, either with or without mandrels. Some of these operations can be carried out either with or without an internal mandrel.

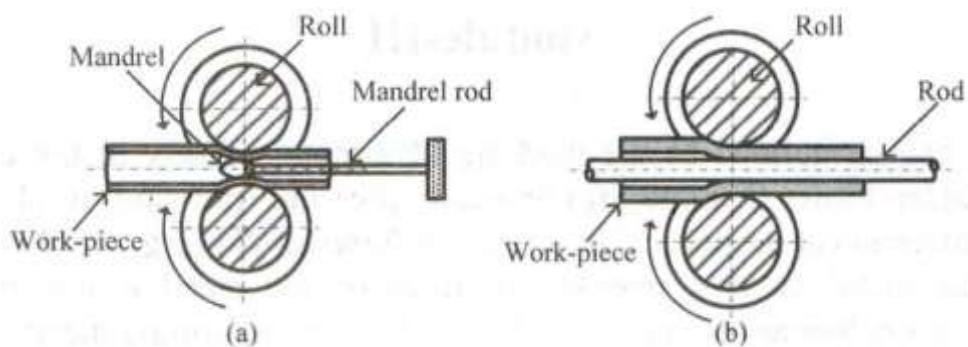

Fig 2.19: Tube rolling

The figure shows the various tube-rolling processes, (a) with a fixed mandrel; (b) with a floating mandrel.

DEFECTS IN ROLLING

The defects in rolling can be classified as *surface defects*, and *structural defects*. The surface defects include rusting and scaling, scratches and cracks on the surface, pits left on the surface due to subsequent detachment or removal of scales. The structural defects are more important rolling defects some of which are difficult to remove. Some common structural defects in rolling are as follows.

Wavy edges - Due to bending of rolls under the rolling pressure, the rolls undergo deflection and the edges of the strip will be compressed more than at the centre. So the edges of the strip obtained will be thinner than the centre waviness in the roller product or edge buckle. Cambering of rolls (diameter of rolls at the centre is made larger than at the edges) can prevent such defects.

Zipper cracks - These cracks occur at the centre of the sheet due to poor material ductility at the rolling temperature.

Edge cracks - These defects are caused due to non-homogeneous plastic deformation of metal across the width.

Alligatoring - Due to friction present between the roll surface and the upper or lower work-piece surface, the elongation on the top and bottom surfaces is less than the deforming material at the centre of thickness. If conditions become severe, it may lead to opening up at the free end of the rolled sheet (like the mouth of an alligator) that is referred to as alligatoring.

Laminations - Laminations mean layers. Some defects like non-metallic inclusions, blow holes are introduced at the time of ingot productions. Under severe reduction, these defects can result into small cracks or laminations. Due to this, the strength along the thickness direction can get drastically reduced.

Residual stresses - Residual stresses can be generated in rolled sheets and plates because of inhomogeneous plastic deformation in the roll gap. The magnitude of residual stress at the surface of a rolled strip depends up on roll diameter, friction, sheet thickness, and reduction in thickness.

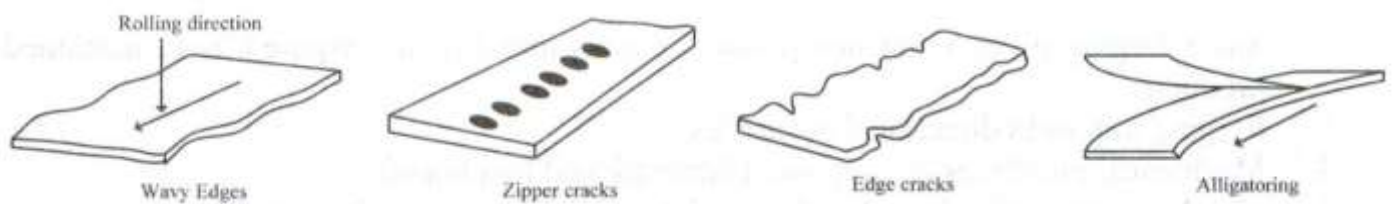

MODULE 3

FORGING

Forging can be defined as the working of a metal, mostly in hot condition, by the application of sudden blows (hammering) or steady pressure (pressing) to obtain useful shape and improve its mechanical properties. In **impact or hammer forging**, rapid blows are given to the surface of the metal. In this, intensity of force on the metal is maximum only at the surfaces and reduces below as the energy is absorbed by the deforming metal. In press forging, the metal is subjected to slow speed compressive forces. Here, the pressure increases as the metal is being deformed and its maximum value is obtained just before the pressure is released. Thus, press forging results in deeper penetration of the deformed zone.

Advantages of forging

- 1) Since forging gives a finished product, excess metal is not required as in machined products.
- 2) Forging improves directional properties.
- 3) Mechanical properties are improved (strength and toughness).
- 4) Metals can be easily shaped to the required dimensions using forging dies.
- 5) Heavy parts can be formed easily compared to other processes.

Limitations of forging

- 1) The initial cost of the equipments and dies are high.
- 2) Maintenance costs of tool and dies is involved.
- 3) Intricate and cored shapes cannot be produced by forging.
- 4) The size and shape is limited as compared to casting process.
- 5) The forged part costs more than the cast part.

Grain flow in casting, machined part and forging

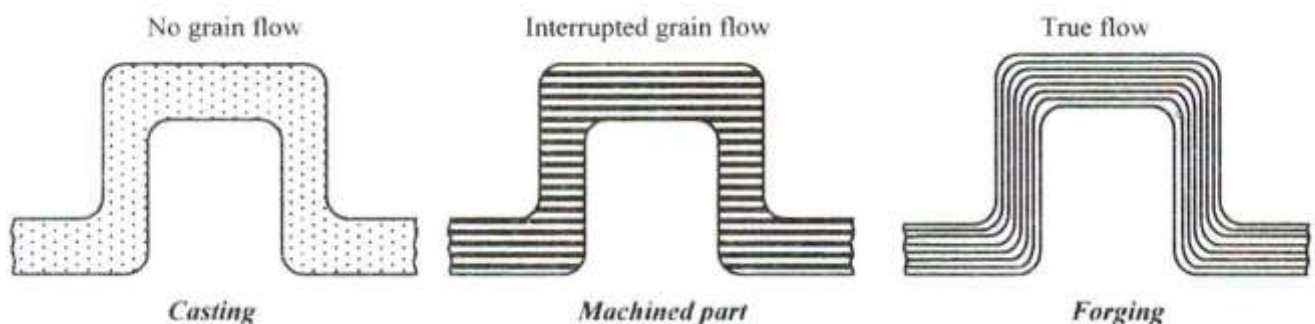

Fig 3.1: Grain flow

In forging, the fibrous structure and the grain structure or the flow lines of the metal are not interrupted, but are made to flow the contour of the forged part. The main objective of good forging design is to control the lines of metal grain flow so that a part with greatest strength and resistance of fracture is produced. In addition, certain mechanical properties like elongation percentage, resistance to shock and vibration are improved. A typical example is shown in the figure which illustrates fibrous structure. The part produced by casting has no grain flow (grains are arranged randomly) and so has mechanical properties. The part made by machining from a bar stock and the fiber of the metal gets interrupted and for this reason the mechanical properties will be poorer than that made by forging. Whereas, in forging the fiber of the metal has not been

interrupted and continues along the entire length of the forged part. Forging produces a grain flow that follows the contours and shape of the part produced. As the internal stresses within the part are channelled along its grain flow, this reduces the internal stress and therefore risk of fracture.

S No.	Forged part	Cast part
1.	Forging refines the grain structure	Grain refining does not take place.
2.	Less defects.	More.
3.	Improved mechanical properties.	Less.
4.	Greater strength and toughness.	Less compared to forged part.
5.	Reduction in weight of the finished part, saving in material possible.	Parts are made bulky so that high stress can be sustained.
6.	Complex shapes cannot be forged.	Complex shapes can be produced.
7.	Minimum machining needed.	More.
8.	High strength to weight ratio.	Low.

FORGEABILITY

Forgeability is the ease with which a given metal can be forged to the required shape. Forgeability is based on such considerations such as the ductility and strength of the metals, forging temperature required and quality of the forging obtained. In general, aluminum, magnesium, copper and their alloys, carbon and low-alloy steels have good forgeability; high temperature materials such as super alloys, tantalum, molybdenum, and tungsten and their alloys have poor forgeability. Various tests have been developed to quantify forgeability; however, because of their complex nature, only two simple tests have had general acceptance.

Upsetting test - In the upsetting test, a solid, cylindrical specimen is upset between flat dies, and the reduction in height at which cracking occurs on the surfaces is noted. The greater the deformation prior to cracking, the greater the forgeability of the metal.

Hot-twist test - In this test, a round specimen is twisted continuously in the same direction until it fails. This test is performed on a number of specimens and at different temperatures, and the number of complete turns that each specimen undergoes before failure at each temperature is plotted. The temperature at which the maximum number of turns occurs then becomes the forging temperature for maximum forgeability.

CLASSIFICATION OF FORGING

All die forging processes can be divided into the following two categories viz., *open die forging* and *closed die forging* (or *impression die forging*).

Open die forging

In open die forging, the work piece is upset, compressed or forged between two flat dies. Open-die forging generally applies to operations with simple dies and tooling and with large deformations. Open-die forging operations are used for producing simple shapes and low production volumes. In open-die forging operations, the part may be rotated between blows for proper shaping of the work-piece during forging. Although most open-die forgings generally weigh 15 kg to 500 kg, forgings as heavy as 275 metric tons have been made. Part sizes may range from very small (the size of nails, pins, and bolts) to very large (up to 23 m, long shafts for ship propellers).

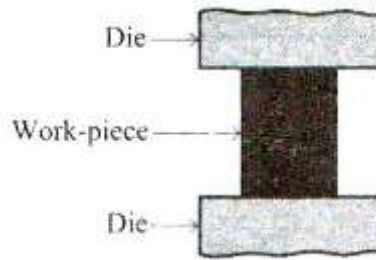

Fig 3.2: Open die forging

Impression die forging (Closed die forging)

In impression die forging, the work-piece takes the shape of the die cavity while being forged between two shaped dies as shown in the figure. This process usually is carried out at elevated temperatures to lower the required forces and attain enhanced ductility in the work-piece. Note in the figure (c) that, during deformation, some of the material flows outward and forms a flash. The flash has an important role in impression-die forging. The process shown in the figure is also referred to as closed-die forging. However, in true closed-die forging, flash does not form (hence the term flash less forging), and the workpiece completely fills the die cavity. Consequently, the forging pressure is very high, and accurate control of the blank volume and proper die design are essential to producing a forging with the desired dimensional tolerances. Closed-die forging operations are used for producing more intricate shapes. Close die forgings have good dimensional accuracy and reproducibility. They are suitable for high production rate. Close die forgings is less time consuming than open-die forging. But in closed die forgings, more than one step required for each forging.

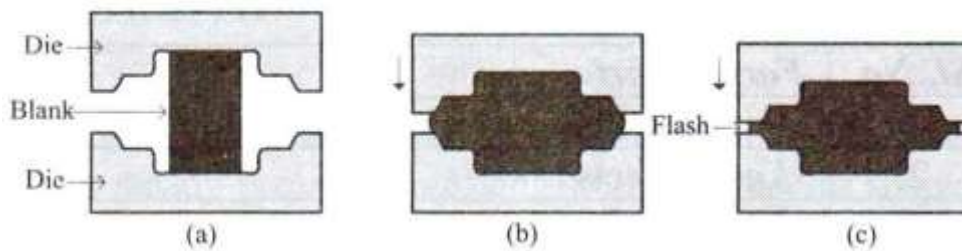

Fig 3.3: Closed die forging

Both open-die and closed-die forgings can be carried out in hot or cold state. Cold forging obviously requires higher deformation energy and is usually carried out for only those materials which are sufficiently ductile at room-temperature. Cold forged parts have better dimensional accuracy and have good surface finish. Hot forged parts although require lower forces but give inferior finish and dimensional accuracy.

S No.	Open die forging	Closed die forging
1.	Work-piece is struck between two flat surfaces.	Cavities or impressions are cut in the dies and the metal is forced to occupy the cavity in the die.
2.	It is used when number of components to be forged is less.	More.
3.	It is used for large sized parts.	It is used for small and medium sized parts.
4.	More time is needed.	Less time.
5.	Less dimensional accuracy.	Good dimensional accuracy.
6.	Complicated shapes can't be obtained.	Complicated shapes can be obtained.
7.	Skilled labour is needed.	Skilled labour is not needed.

8.	Initial cost is less.	Initial cost is high.
----	-----------------------	-----------------------

FORGING DIE DESIGN

Dies are employed for the production of forgings in large quantities. Correct design of die can affect both the cost of production and quality of the forged part. The design of forging dies requires knowledge of the strength and ductility of the work-piece material, its sensitivity to deformation rate and temperature, frictional characteristics, and the shape and complexity of the work-piece. Die distortion under high forging loads can be an important consideration, particularly if close tolerances are required.

Forging die design features

The terminology for forging dies is shown in the figure and the significance of various parameters is described below. The most important rule in die design is that the part or work-piece material will flow in the direction of least resistance.

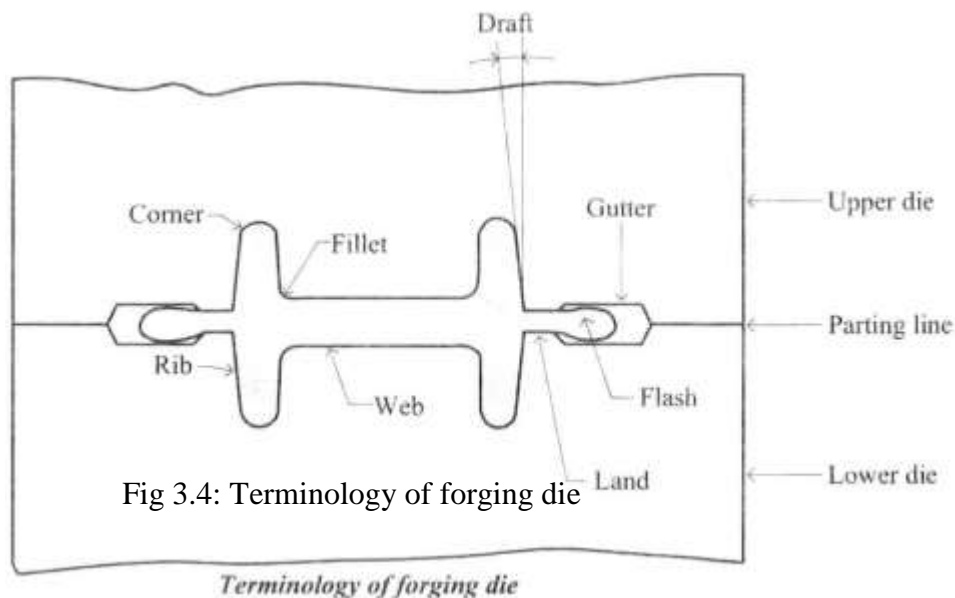

Parting line - The parting line is the plane that divides the upper die from the lower die. It is the Draft plane where the two die halves meet. Its selection by the designer affects grain flow in the part, required load, and flash formation. For most forgings the parting line is usually at the largest crosssection of the part. For simple symmetrical shapes the parting line is usually a straight line at the center of the forging, but for more complex shapes the line may not lie in a single plane.

Draft- Draft is the amount of taper on the sides of the part required to remove it from the die. The term also applies to the taper on the sides of the die cavity. Typical draft angles are 3° on aluminum and magnesium parts and 5° to 7° on steel parts. Draft angles on precision forgings are near zero.

Webs and ribs -A web is a thin portion of the forging that is parallel to the parting line, while a rib is a thin portion that is perpendicular to the parting line. These part features cause difficulty in metal flow as they become thinner.

Fillet and corner radii - Selection of the proper radii for comers and fillets is important in order to ensure smooth flow of the metal in the die cavity and to improve die life. Small radii are generally undesirable because of their adverse effect on metal flow and their tendency to wear rapidly because of stress

concentration. Therefore, the size of fillets should be large as possible.

Flash - Flash is the material in forging that is not constrained by the cavities and flows outwards from the die. Flash must travel through a narrow passage, called land, before it opens up into a gutter. Flash formation plays a critical role in impression-die forging by causing pressure buildup inside the die to promote filling of the cavity. This pressure buildup is controlled by designing a flash land and gutter into the die. The land determines the surface area along which lateral flow of metal occurs, thereby controlling the pressure increase inside the die. The gutter permits excess metal to escape without causing the forging load to reach extreme values.

Shrinkage factor - All metals shrink upon cooling. So this factor must therefore be considered.

Machining allowances- Machining operation may be carried out to obtain the exact dimension or to obtain smooth surface finish. So suitable allowance should be given.

Pre-shaping

In a properly pre-shaped work-piece, the material should not flow easily into the flash (otherwise die filling will be incomplete), the grain flow pattern should be favorable for the products' strength and reliability, and sliding at the work-piece-die interfaces should be minimized in order to reduce die wear.

Forging die materials

Because most forgings, particularly large ones, are performed at elevated temperatures, die materials generally must have strength and toughness at elevated temperatures, resistance to mechanical and thermal shock, and resistance to wear (particularly to abrasive wear, because of the presence of scale on heated forgings). Selection of die materials depends on the size of the die, the composition and properties of the work-piece, the complexity of the work-piece shape, the forging temperature, the type of operation, the cost of die material, the number of forgings required, and the heat-transfer and distortion characteristics of the die material. Common die materials are tool and die steels, which contain chromium, nickel, molybdenum, and vanadium.

Lubrication in forging

A wide variety of metalworking fluids can be used in forging. Lubricants greatly influence friction and wear. Consequently, they affect the forces required, die life, and the manner in which the material flows into the die cavities. Lubricants can also act as a thermal barrier between the hot work-piece and the relatively cool dies; thus slowing the rate of cooling of the work-piece and improving metal flow. Another important role of the lubricant is to act as a parting agent, preventing the forging from sticking to the dies and helping release it from the die.

Die inserts

In closed-die forging, the parts of the die which are subjected to excessive wear caused by the flow of metal are usually designed with exchangeable inserts, that is instead of one piece solid die block, the impressions are sunk in inserts which are then secured in die holders. Die inserts used in forging automotive axle housing is shown in the figure.

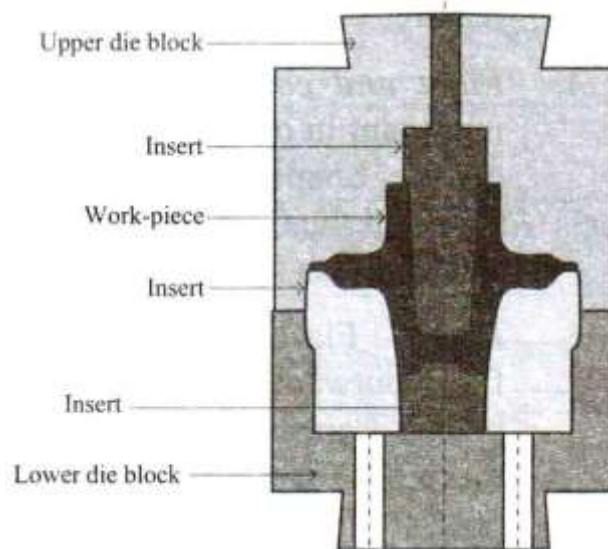

Fig 3.5: Die inserts used in forging an automotive axle housing

Advantages of die inserts

1. Instead of replacing the complete die block, only the insert will be replaced when it is worn out.
2. Handling of inserts is easier as compared to solid die blocks.

Disadvantages of die inserts

1. The use of inserts is suitable only for round and symmetrical parts with a single parting plane and which can be forged in a single die impression.

FORGING METHODS

Several methods related to the basic forging process are carried out in order to impart the desired shape and features to forged products. They are discussed below.

Upsetting

Upsetting is carried-out to increase the thickness or diameter of a material and to reduce its length. This is done generally to obtain localized increase in thickness. For example, forming of a bolt head. The heated metal is held by tong at one end and supported by anvil at other end. Then pressure is applied on the job by means of a hammer or dropping weight from a convenient height.

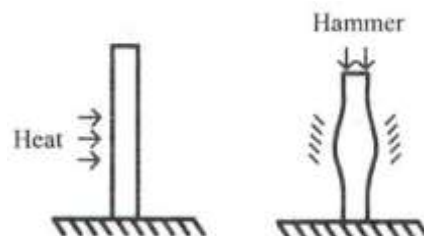

Fig 3.6: Upsetting

Drawing down

It is used to reduce the thickness of a bar and to increase the length. This operation is carried out by

hammering the hot work-piece keeping it on the anvil and holding it by a suitable tong. The angles between the hammer face, the metal and the anvil will decide the shape of finished work.

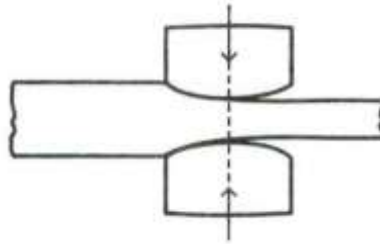

Fig 3.7: Drawing down

Fullering

It is used to reduce the cross-sectional area of a portion of a stock. The metal flow is outwards and away from the center of the fullering tool. By fullering, metal cross-section is decreased and its length is increased.

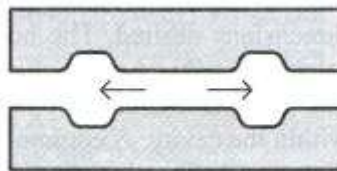

Fig 3.8: Fullering

Edging

Edging is the process of concentrating material using a concave shaped open die. The process is called edging, because it is usually carried out on the ends of the work-piece. It is used to shape the ends of bars and to gather metal.

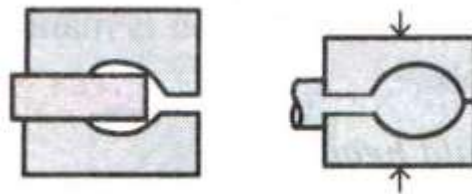

Fig 3.9: Edging

Swaging

Swaging is done to reduce and finish work to the desired size and shape, usually round or hexagonal. Swaging is usually a cold working process; however, it is sometimes done as a hot working process.

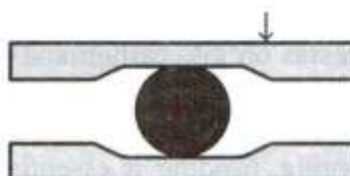

Fig 3.10: Swaging

Forge welding

In forge welding, the parts to be welded are heated to a temperature of about 1000 °C. Then the mating surfaces are then upsetted, then a cleft shape is formed at the mating surface and is joined by applying excess pressure at the mating surfaces. This forms a strong weld. Forge welding can be carried-out for wrought iron and low carbon steels.

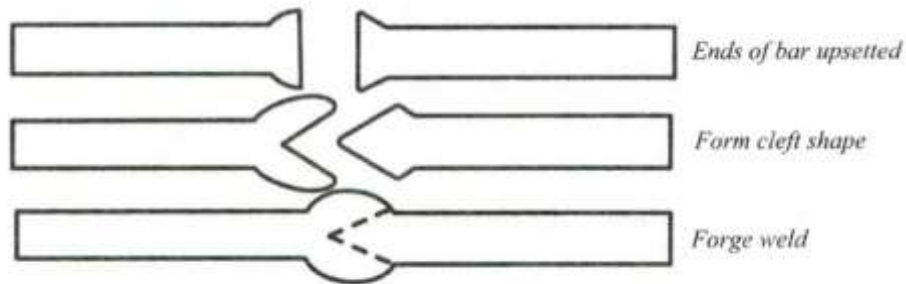

Fig 3.11: Forge welding

Piercing

Piercing is used to create a cavity or hole in the work piece. Piercing does not break through the metal's surface, like a drilling operation. Instead, the cavity is pressed into the work, hence it is a forging operation. The work-piece may be confined in a container (such as a die cavity) or may be unconstrained. The piercing force depends on (a) the cross-sectional area and the tip geometry of the punch, the strength of the material, and the magnitude of friction at the sliding interfaces. A common example of piercing is the indentation of the hexagonal cavity in bolt heads. Piercing may be followed by punching to produce a hole in the part. In piercing operation there won't be any scrap metal produced.

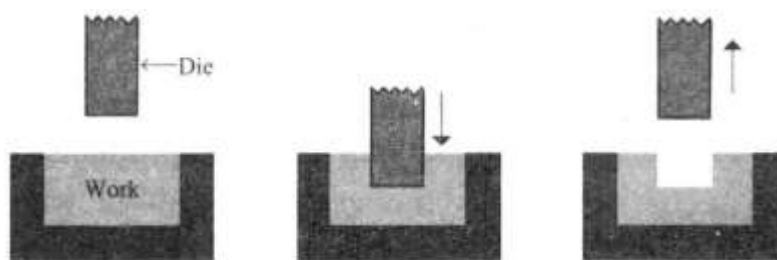

Fig 3.12: Piercing

Hobbing

Hobbing is a cold working, metal forging process in which a punch, with an exact geometry at its end, is pressed into a work piece. The special punch, called a hob, will create a cavity with the precise dimensions desired. The hob is most often machined from hardened steel. Due to the high tolerances of the hob, the high pressures applied during the manufacturing process, and the fact that the operation is performed cold, very accurate dimensions and surface quality are obtained within the cavity. A common application of hobbing in modern industry is to produce molds or die cavities for other manufacturing processes such as plastic molding, die casting, and other metal forging processes. Pressing the hob into the metal is easier than machining the work. Also, once the hob is manufactured, it is easy to produce many identical cavities with the same hob.

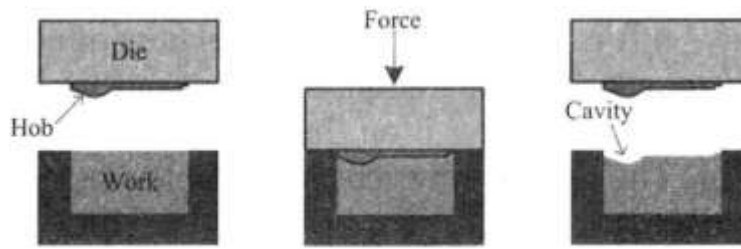

Fig 3.13: Hobbing

Cold heading

Cold heading or cold forging may be carried out in mechanical or hydraulic presses on low carbon and low alloy steels. It is used for producing parts which are symmetric about the axis. Also called upset forging, heading is essentially an upsetting operation, usually performed on the end of a round rod or wire in order to increase the cross section. Heading can be carried out cold, warm, or hot.

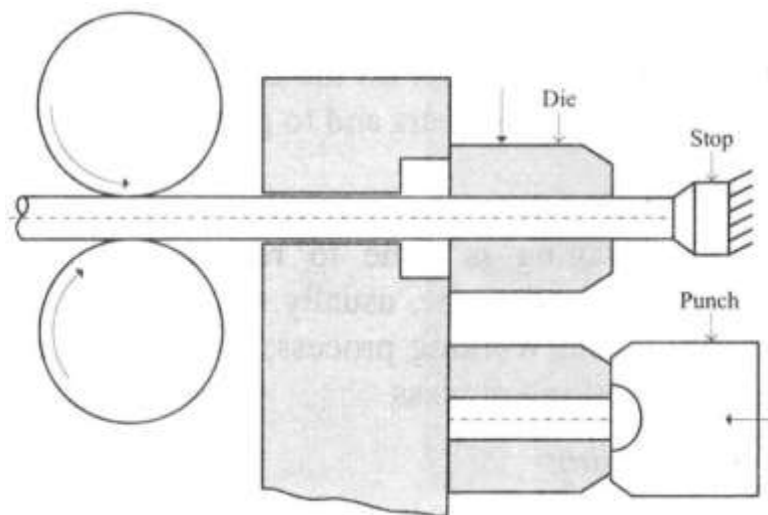

Fig 3.14: Cold heading

A cold heading operation is depicted in the figure. In the process, the metal is fed through die till stop. Then the die is moved down to cut off by shearing and is brought to the heading line where the required head is formed by a blow of punch.

Small parts such as nails, rivets, pins, screws, bolts can be produced in large quantities using this technique.

In this process (also known as radial forging, rotary forging, or simply swaging), a solid rod or tube is subjected to radial impact forces by a set of reciprocating dies of the machine. The tube is subjected to series of blows from dies which rotates around the metal piece. The dies are engaged in a slot provided in a spindle which rotates at a fairly higher speed. Spindle is allowed to rotate in a cage containing a number of small rolls. As the spindle rotates the die passes between pairs of opposite rolls, which closes the dies. The dies are opened and closed alternatively as they pass between the gaps. The work-piece, rolls and housing is stationary while the dies rotate (while moving radially in their slots), striking the work-piece at rates as high as 20 strokes per second. The metal placed in the die is squeezed to the required shape.

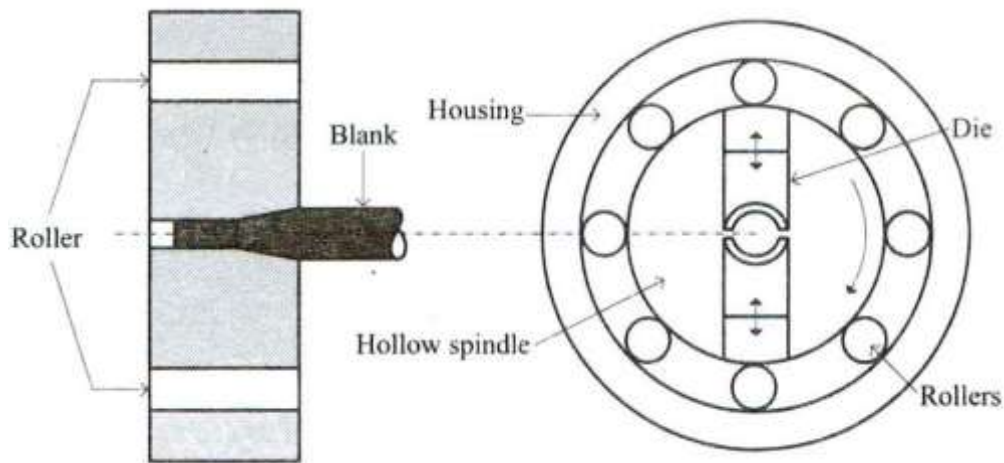

Fig 3.15: Rotary swaging

Round bars or tubes can be reduced in their diameters by this process. It can be done in both cold and hot state. Nozzle of welding torch is produced by this method. Swaging also can be used to assemble fittings over cables and wire; in such cases, the tubular fitting is swaged directly onto the cable. Swaging generally is limited to a maximum work-piece diameter of about 150 mm; parts as small as 0.5 mm has been swaged. Swaging is a versatile process and is limited in length only by the length of the bar supporting the mandrel (if one is needed).

Precision forging

In order to reduce the number of additional finishing operations required-hence the cost-the trend has been toward greater precision in forged products (net-shape forming). Typical precision-forged products are gears, connecting rods, and turbine blades. Precision forging requires special and more complex dies, precise control of the blank's volume and shape, and accurate positioning of the blank in the die cavity. Also, because of the higher forces required to obtain fine details on the part, this process requires higher capacity equipment.

Aluminum and magnesium alloys are particularly suitable for precision forging because of the relatively low forging loads and temperatures that they require; however, steels and titanium also can be precision forged.

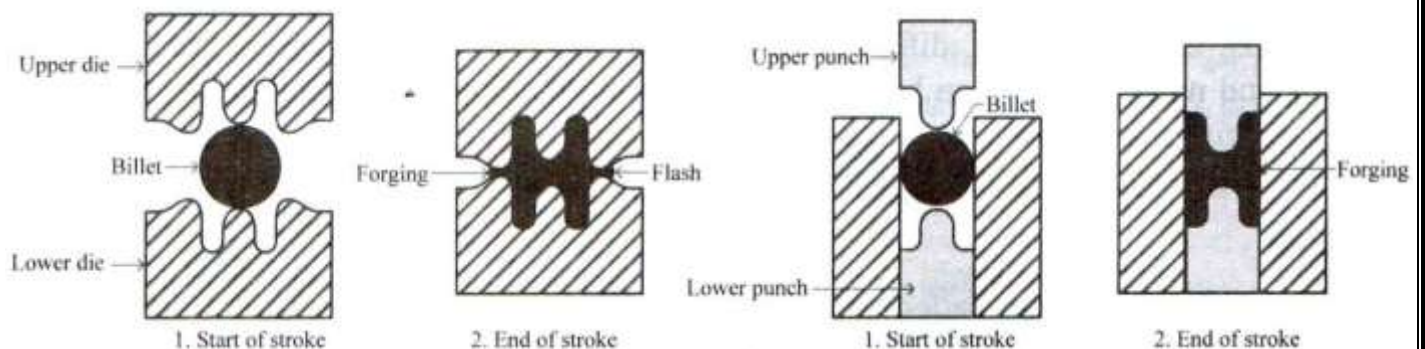

Fig 3.16: Comparison of closed-die forging with flash and precision or flashless forging of a round billet

Skew rolling

Skew rolling is a metal forging process that uses two specially designed opposing rolls that rotate continuously. Round stock is fed into the spiral shaped rolls. The material is forged by each of the grooves in

the rolls and emerges from the end as a metal ball. The stock is fed through the rolls continuously, but each ball is produced separately, thus it is a discrete process and not a continuous one. Skew rolling, similar to roll forging, is a manufacturing process that bears qualities of both metal rolling and metal forging.

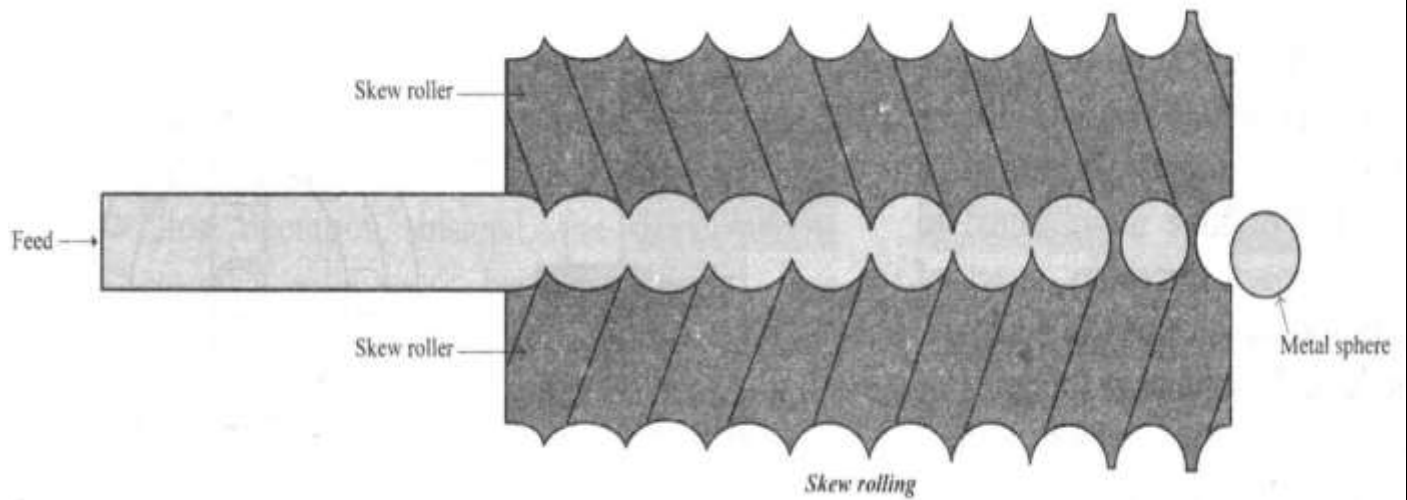

Fig 3.17: Scew Rolling

Roll forging

In roll forging, (also called roll forming), the cross section of a round bar is shaped by passing it through a pair of rolls with profiled grooves. Even though roll forging uses rolls in order to accomplish the deformation of the material, it is classified as a metal forging process and not a rolling process. More similarly to metal forging than metal rolling, it is a discrete process and not a continuous one. Roll forging is usually performed hot. The precisely shaped geometry of grooves on the roll, forge the part to the required dimensions.

The forging geometry of the rolls used to forge metal parts is only present over a portion of the roll's circumference. Only part of a full revolution of a roll is needed to forge the work piece. Typically in manufacturing industry, the forging geometry on the rolls may occupy from one quarter to three quarters of the roll's circumference. The non grooved portion of the roll's revolution is useful for feeding the stock during the process. Roll forging typically is used to produce tapered shafts and leaf springs, table knives, and hand tools.

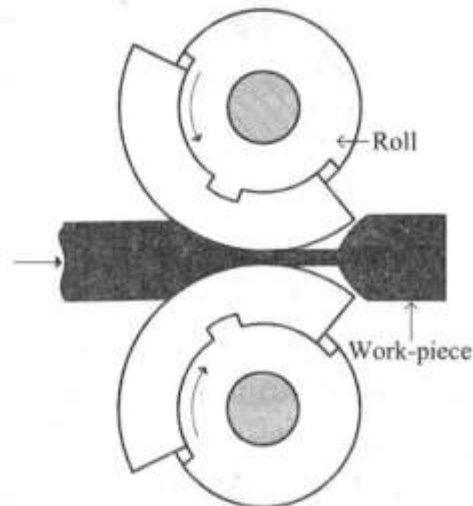

Fig 3.19: Roll Forging

FORGING EQUIPMENTS

Forging equipment of various designs, capacities, speeds, and speed-stroke characteristics is available. Forging equipment may be divided into three main categories viz., hammers, forging presses and forging machines or upsetters.

Forging hammers

Hammers impart stress on the material by impact, and they usually operate in a vertical position. They are impact machines. Hammers derive their energy from the potential energy of the ram, which is then converted to kinetic energy; thus, hammers are energy limited. The speeds of hammers are high; therefore, the low forming times minimize cooling of the hot forging, allowing the forging of complex shapes, particularly with thin and deep recesses. To complete the forging, several blows may have to be made on the part. In power hammers, the ram is accelerated in the down-stroke by steam or air, in addition to gravity. The highest energy available in power hammers is 1150 kJ.

1. Drop board hammer

Gravity drop hammers make use of power hammers that are raised to certain height and then released to give blow on the work. Such hammers which are raised and dropped are called drop hammers and hence the name drop forging. In this, a heavy mass (ram) is mounted on a wooden or steel board which passes between two pinch rolls. The heated metal is kept in the lower portion and is struck with one or more blows with the upper die causing metal to flow to fill the die cavity. During operation, using the rolls the board along with the ram is raised to a predetermined height and is allowed to fall under gravity. Gravity drop hammers make use of closed impression dies to perform the operations. One half of die will be attached to the hammer and other to the anvil. Ram weights range up to 4500 kg, with capacities ranging up to 45 kN.

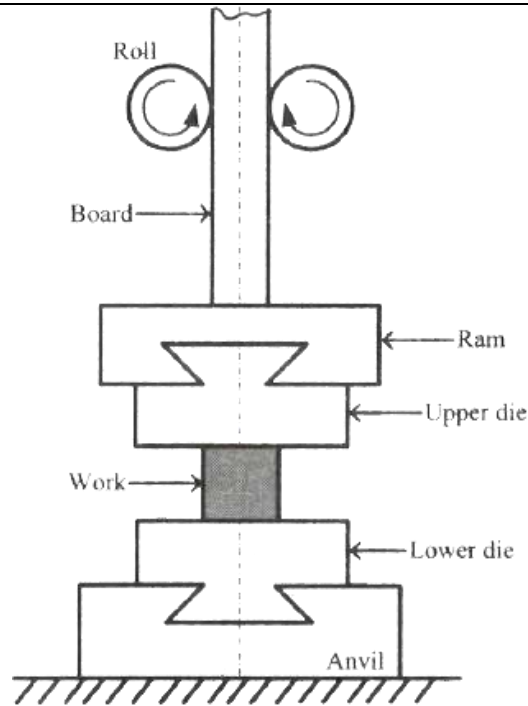

Fig 3.20: Drop board hammer

2. Pneumatic hammer

A pneumatic forging hammer has two cylinders a compressor cylinder and a ram cylinder. Air is compressed on both upward and downward strokes of the piston in the compressor cylinder and is delivered to the ram cylinder where it actuates the ram of the ram cylinder, delivering the forging blows to the work-piece. The reciprocation of the compressor piston is obtained from a crank drive which is powered from an electric motor through a reducing gear. The size of the pneumatic hammer may vary from 50 kg to 1000 kg. Hammers operate at 70 to 190 blows per minute. The capacity of pneumatic hammers usually varies from 0.5 to 10 kN.

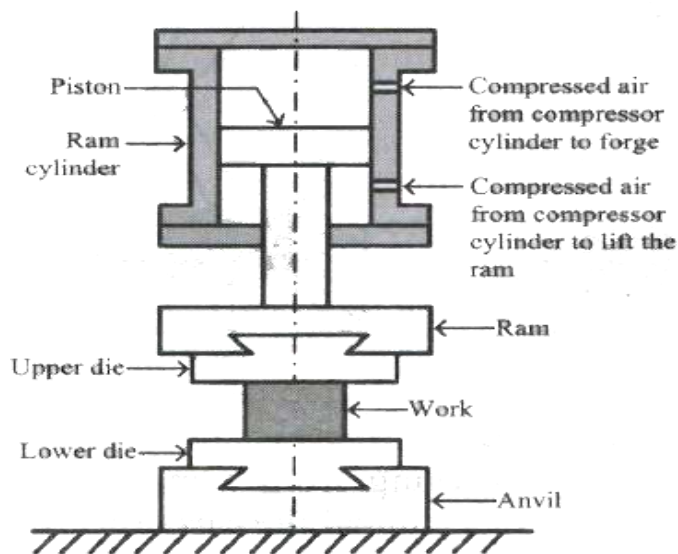

Fig 3.21: Pneumatic hammer

3. Steam hammer

Steam or air hammers make use of steam or compressed air. They have no in-built compressor and therefore additional facilities are required for supplying high pressure steam or compressed air. Pressure exerted by the steam forces the ram which is the integral part of piston to give blows to work-piece held between the dies. There are two types of steam hammers viz., single acting steam hammer and double acting steam hammer. In the case of single acting hammer the steam raises the ram but it falls due to gravity. In the case of double acting hammer the steam raises the ram and makes it fall so that energy of blow is increased. The capacity of steam hammers usually varies from 2 kN to 100 kN.

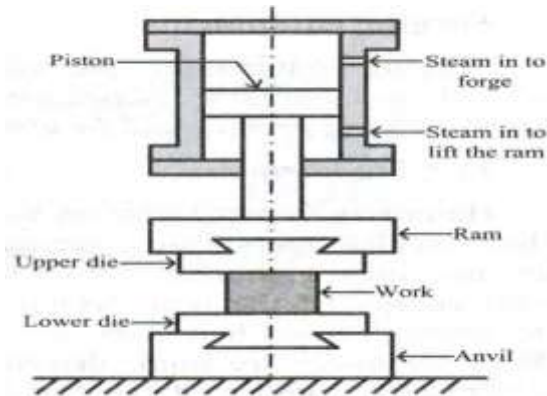

Fig 3.22: Steam hammer

4. Counterblow hammers

Counter-blow hammers have two rams that simultaneously approach each other to forge the part. They are generally of the mechanical / pneumatic/ mechanical-hydraulic type. These machines transmit less vibration to the foundation than other hammers. The largest counterblow hammer has a capacity of 1250 kN.

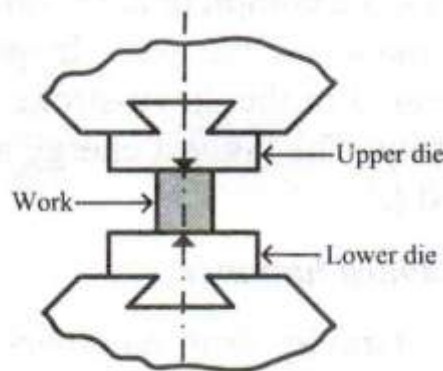

Fig 3.23: Counterblow hammers

FORGING PRESSES

In forging presses, the compressive force is applied continuously and the material is gradually pressed or squeezed into shape. They also usually operate in a vertical position like the hammers. The various forging

presses employed for the forging process are discussed below.

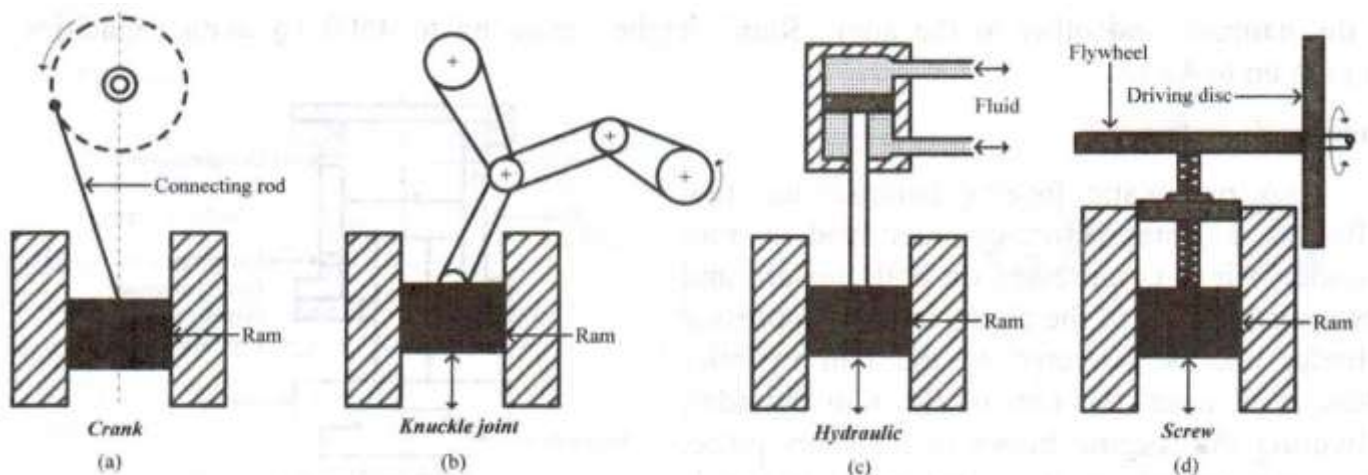

Fig 3.24: Forging press

Mechanical presses

They are of either the crank (a) or the eccentric type (b), with speeds varying from a maximum at the centre of the stroke to zero at the bottom, hence mechanical presses are stroke limited. The force available depends on the stroke position and becomes extremely large at the bottom-dead-centre position; thus, proper setup is essential to avoid breaking the dies or other equipment.

Mechanical forging presses make use of an electric motor to drive a flywheel mounted on a counter shaft. The power is transmitted from the pulley of the motor to the flywheel by means of a belt drive. Power from the counter shaft is transmitted to the crank shaft by means of gearing. Connecting rod mounted on crankshaft converts the rotating motion into reciprocating motion. Ram which is attached to the connecting rod gives blows to the work-piece held between the die. The largest mechanical press has a capacity of 107 MN. Speed ranges from 25 to 100 strokes per minute.

Hydraulic presses

Hydraulic presses (c) have a constant low speed and are load limited. Large amounts of energy can be transmitted to the work-piece by a constant load available throughout the stroke. A hydraulic press typically consists of pistons, cylinders, rams, and hydraulic pumps driven by electric motors. Ram speed can be varied during the stroke. These presses are used for both open-die and closed-die forging operations. The largest hydraulic press in existence has a capacity of 670 MN. Compared with mechanical presses, hydraulic presses are slower and involve higher initial costs, but they require less maintenance.

Screw presses

Screw presses (d) derive their energy from a flywheel. The forging load is transmitted through a vertical screw. These presses are energy limited and can be used for many forging operations. Screw presses consist of a screw which passes through a nut. The head of the screw is connected to the flywheel and the tail end is joined with the ram. The ram is moved up and down by the screw as the flywheel is driven by rotating discs (driving discs). They are particularly suitable for producing small quantities, for parts requiring precision (such as turbine blades) and for control of ram speed. The largest screw press has a capacity of 280 MN.

Advantages of press forging over drop forging

- 1) Press forging is considerably quieter operation than drop forging.
- 2) Press forging is normally faster than drop forging since only one squeeze is needed at each die impression.
- 3) Alignment of two halves of dies more easily maintained than with hammering.
- 4) Structural quality of the product is superior to drop forging.
- 5) With ejectors in the top and bottom dies, it is possible to handle reduced die drafts. Forgings obtained will thus be more accurate. Also, reduced die drafts reduce the weight of the charge and subsequent machining of the work-piece.
- 6) High longitudinal and transverse stability of press contributes to fine accuracies and this result in uniform forgings with exacting tolerances and low machining allowances.
- 7) The number of strokes and ram speed are high (for mechanical press) and the ejectors release the forgings from the dies immediately after the deformation has taken place. The shorter contact periods, thus obtainable in mechanical die forging presses, increase die life.
- 8) Simple handling enables high output even with unskilled operators.
- 9) Mechanization of work-piece transfer further increases productivity.
- 10) Low susceptibility to failure and simple maintenance.
- 11) Die forging presses are ecologically safer than forging hammers and screw presses.

Upset forging

Upset forging or machine forging machine is similar in design to crank-type forging presses but they are mounted horizontally. These machines are intended for hot upsetting and piercing of forgings from bars 13 mm to 250 mm in diameter in multi-impession dies. They are mainly suitable for manufacture of all kinds of parts with stems and shoulder at the end or in the middle, with or without a hole in the face, such as, bolts, pins, nuts, bushings, blank caps for gear wheels, etc. These machines are available with the working force of 1 MN to 30 MN and over, the force being developed at the end of the slide stroke. Horizontal forging machines are rated or specified for size by the diameter of the largest bar size they can handle.

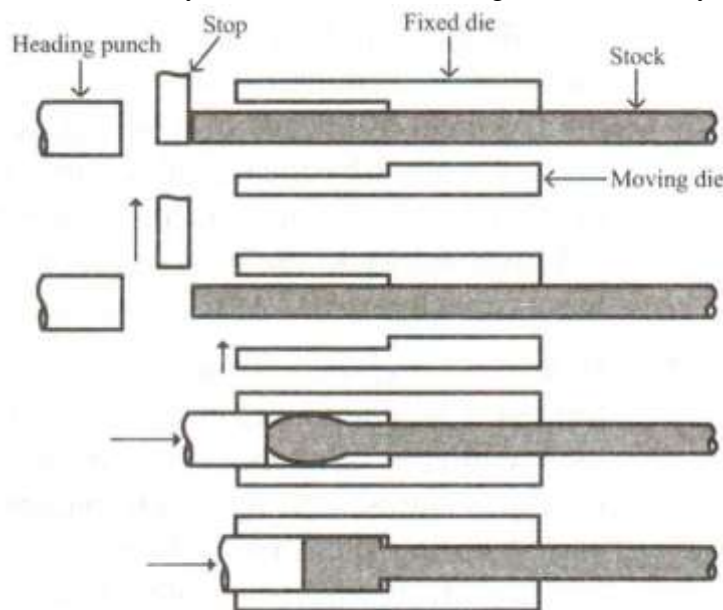

Fig 3.25: Upset forging

In machine forging, the material is plastically deformed by squeeze pressure into the shape provided by the dies in the forging machine. It consists of a stationary die, a moving die, stop and a heading punch. Heated end of the work-piece is inserted in the stationary die and pushed forward until the stop. Then the moving die is moved against the stationary die so that a desired impression is formed on the metal part and the work-piece is tightly gripped. Stop is then allowed to move aside. Then the header punch is advanced against the metal head to upset the metal. After the metal completely fills the die impression, both heading punch and moving die are withdrawn to their original positions.

Advantages of upset forging

- 1) Better quality of forging.
- 2) Since there is no or little draft is needed on forging made by upsetters, therefore, there is saving in material and also machining expenses.
- 3) The upsetting process can be automated.
- 4) As compared to drop forging hammers, forging machines have a higher productivity and their maintenance is much cheaper.
- 5) In forging machine the forging is accompanied by little or no flash.

Disadvantages of upset forging

- 1) High tooling cost.
- 2) It is difficult to forge intricate, non-symmetric and heavy jobs on a forging machine.
- 3) Owing to the material handling difficulties it is not convenient to forge heavier jobs.
- 4) The maximum diameter of the stock which can be upset is limited (about 250 mm)

DEFECTS IN FORGED PARTS

Various surface and body defects may be observed in forging. The kind of defect depends upon a lot of factors such as forging process, poor quality of stock, improper heating, incorrect die design, uneven cooling of stock after forging, etc.

The most commonly found forging defects are as follows.

Mismatch - This is due to the misalignment between the top and bottom forging dies. This may be caused due to loose wedges. This results in a lateral displacement between the portions of the forging.

Scale pits - These are shallow surface depressions caused by not removing scale from the dies. The scale is worked into a surface of the forging. When this scale is cleaned from the forging, depression remains which are known as scale pits.

Cold shuts or laps- Cold shuts or laps are short cracks, which usually occur at corners and at right angles to the surface. They are caused by metal surface folding against itself during forging. Sharp corners in dies can result in hindered metal flow, which can produce laps.

Unfilled section - This defect is similar to misrun in casting and occurs when the metal does not completely fill the die cavity. It is caused by using insufficient metal or insufficient heating of the metal.

Burnt and overheated metal- This defect is due to improper heating conditions and soaking the metal too long time.

Cracks- Cracks occur on the forging surface may be longitudinal or transverse. These are due to bad quality of ingot, improper heating, and forging at low temperature.

Fins and rags-These are small projections or loose metal driven into forging surface.

Dirt, slag and sand- These may be present on the surface of the forging due to their presence in the ingot used for forging.

Internal cracks- Internal cracks in forging can result from too drastic a change in the shape of the raw stock at too fast a rate.

INSPECTION OF FORGED PARTS

Inspection of forgings ensures high quality product. Various inspection tests for forgings are discussed below.

Visual inspection - Defects which are easily located by visual inspection are surface cracks, hot tears, blowholes, metal penetration etc. Inspection is carried out by using naked eye or by using magnifying glasses.

Geometric checking for shape and dimensions - Dimensional accuracy of the casting is carried out by checking the casting with drawings aided by gages (micrometers, etc.). A number of methods are used to check the dimensional accuracy which includes micrometers, manual and automatic gages, co-ordinate measuring devices, etc.

Metallurgical and chemical tests- Involves pressure testing, leak testing, etc.

Testing of mechanical properties (destructive and semi-destructive tests) – These tests involves tensile test, hardness test, creep test, etc .

Non-destructive tests - These tests consists of radiography, magnetic particle inspection, ultrasonic inspection, dye - penetrant and fluorescent penetrant inspection, etc.

ANALYSIS OF FORGING

Forging of a rectangular work piece in plane strain

Let's take the case of simple compression with friction, which is the basic deformation process in forging. As the flat dies compress the part, it is reduced in thickness, and, because the volume of the part remains constant, the part expands laterally. This relative movement at the die-work-piece interfaces causes frictional forces acting in the opposite to the movement of the piece. These frictional forces are shown by the horizontal arrows in the figure. For simplicity, let's also assume that the deformation is in plane strain; i.e., no normal and shear strain along the z direction (depth direction).

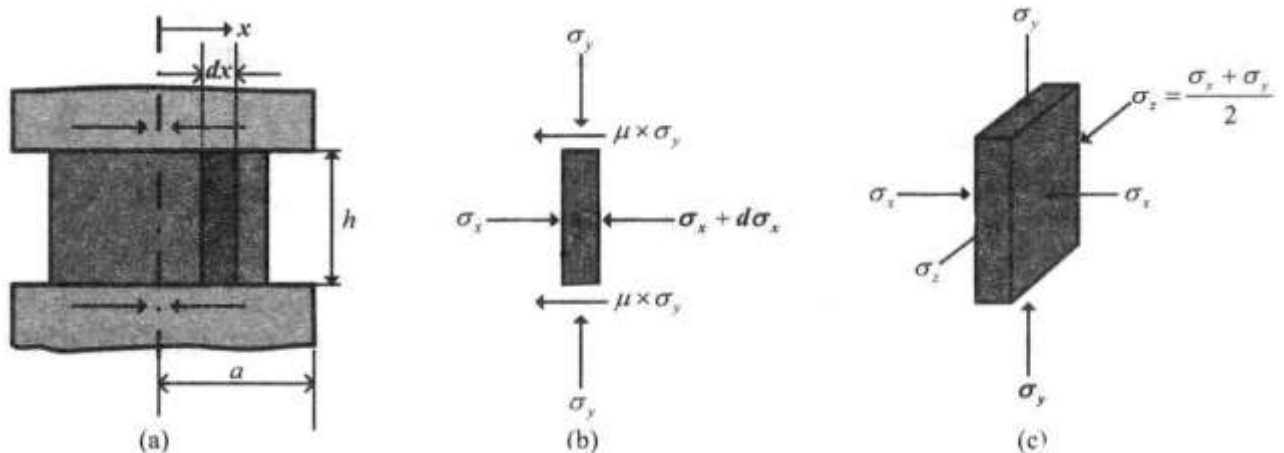

Fig 3.26: Forging analysis

Consider the elemental strip of width dx , height, h and unit depth, as shown and indicate all the stresses acting on it. Note the correct direction of the frictional stresses. Also note the difference between the horizontal stresses acting on the sides of the element; this difference is caused by the presence of frictional stresses on the element. We assume that the lateral stress distribution, σ_x is uniform along the height, h .

FORGING UNDER STICKING CONDITION

The product of μ and p is the frictional stress (surface shear stress) at the interface at any location x from the center of the specimen. As p increases toward the center, $\mu \times p$ also increases. However, the value of $\mu \times p$ cannot be greater than the shear yield stress k of the material. When $\mu \times p = k$, sticking takes place. Sticking does not necessarily mean adhesion at the interface; it reflects the fact that, relative to the plate surfaces, the material does not move.

EXTRUSION

Extrusion is a process of forcing a metal enclosed in a container to flow through the opening of a die. The metal is subjected to plastic deformation. Metal undergoes reduction and elongation during extrusion. Extrusion is used to manufacture rods, tubes, variety of circular, rectangular, hexagonal and other shape both in solid and hollow form, channel, I, Z, T and other sections. Extrusion may be done hot as well as cold. An extrusion press has three major components viz., container, die and ram. Different methods of extrusion are discussed below.

Direct extrusion

In direct extrusion or forward extrusion, the flow of metal through the die is in the same direction as the movement of ram. Hot billet is placed within the container that has die at one end. A ram forces the billet through the die opening, producing the extruded product. The die may be round or it may have various other shapes. The ram is close fitted to the container cavity consequently preventing the backward flow of metal and controlling the flow of the material in the same direction as the ram.

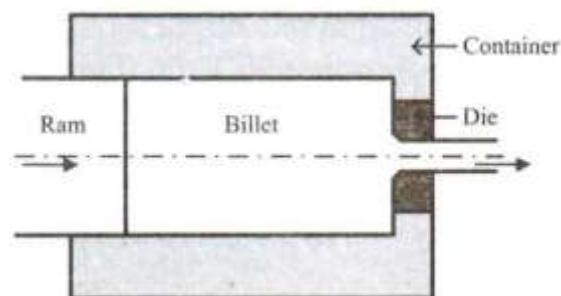

Fig 3.27: Direct extrusion

Indirect extrusion

In indirect extrusion or backward extrusion, the metal flows in the opposite direction to the movement of ram. Ram used is hollow and die is mounted over the bore of ram. Billet remains stationary while die is pushed into the billet by the hollow ram. Indirect extrusion does not require much force as compared to direct extrusion as it involves no friction between metal billet and container walls. The equipment employed is more

complicated in order to accommodate the passage of the extruded shape through the centre of the hollow ram. Indirect extrusion is not common as ram must be hollow. The disadvantage of backward extrusion is that the surface defects of the billet would end up in the final product unlike direct or forward extrusion where these are discarded in the extrusion container. Direct extrusion, indirect extrusion and backward extrusion normally use heated billet for the operation. So those processes are called hot extrusion. Aluminium, copper with their alloys is successfully used to manufacture products using hot extrusion process. Electrical wires, bars and tubes are some of the items produced.

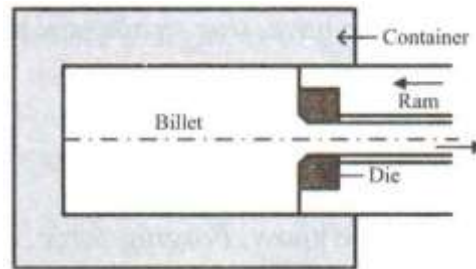

Fig 3.28: Indirect extrusion

Cold extrusion

In cold extrusion or impact extrusion, cold billet is used. The process is similar to backward extrusion. But it is carried out at a higher velocity. Small unheated metal is placed in the die cavity. Punch is forced into the die cavity causing the metal to flow upwards through the gap between punch and die. Good surface finish can be obtained by this method. Thin wall parts may be produced by impact extrusion, which is difficult to cast. Collapsible medicine tubes and toothpaste tubes are made in this way.

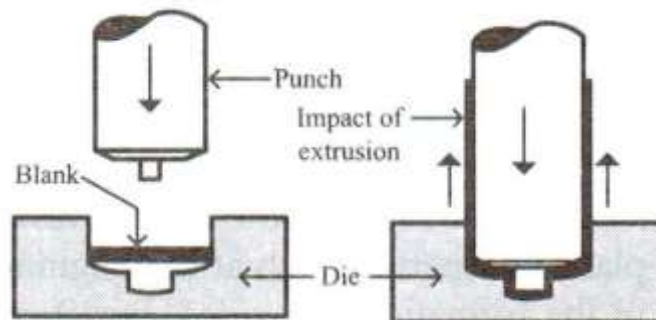

Fig 3.29: Cold extrusion

Hydrostatic extrusion

In hydrostatic extrusion, billet is surrounded by a working fluid which is pressurized by ram to provide the extrusion process. Hydrostatic extrusion is actually a form of direct extrusion. The force delivered through the ram is what pressurizes the liquid. The liquid applies pressure to all surfaces of the work billet. When the ram moves forward, it is the force from the incompressible fluid that pushes the work through the die, extruding the metal part. This type of extrusion avoids the friction between metal piece and the container. Less ductile metal can be extruded by this method.

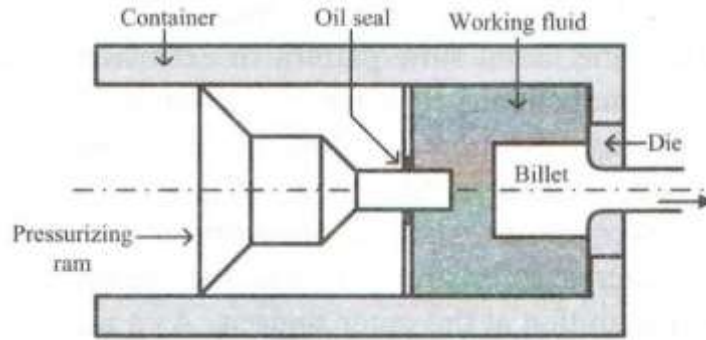

Fig 3.30: Hydrostatic extrusion

Hooker process

In the hooker process or extrusion down method, a cup is first formed by a suitable working operation. Extrusion then consists of elongating and thinning the walls of cup, using a punch and die. This cold working direct extrusion process is commercially applied mainly for the production of small, thin walled copper and aluminium seamless tubes and cartridge cases.

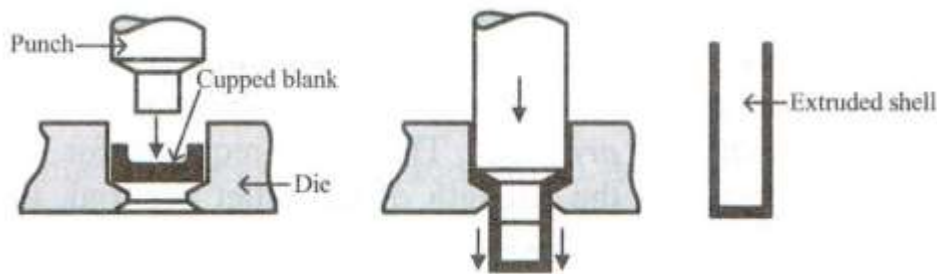

Fig 3.31: Hooker Process

S No.	Forward / Direct Extrusion	Backward / Indirect Extrusion
1.	The flow of metal is in the same direction as the movement of ram.	In this case the metal flows in the opposite direction to the movement of ram.
2.	High friction forces must be overcome.	Low friction forces are generated as the mass of material does not move.
3.	High extrusion forces required but mechanically simple and uncomplicated.	25-30% less extruding force required as compared to direct extrusion. But hollow ram required limited application.
4.	High scrap or material waste about 18- 20% on an average.	Low scrap or material waste, only 5-6% of billet weight.

S No.	Hot extrusion	Cold extrusion
1.	Heated billet is used.	Unheated billet is used.
2.	Less ductile metals can be extruded.	Ductile metal only can be extruded.
3.	More scrap.	Less scrap.
4.	Less surface finish.	Good surface finish.

5.	Less expensive.	Expensive.
6.	Oxidation and scales on surfaces exists.	No oxidation and scales on surfaces.
7.	Low production rate.	Higher production rate.

METAL FLOW IN EXTRUSION

Because the billet is forced through a die, with substantial reduction in its cross section, the metal flow pattern in extrusion is an important factor in the overall process. The most homogeneous flow pattern is obtained when there is no friction at the billet-container-die interfaces. This type of flow occurs when the lubricant is very effective or with indirect extrusion. When friction along all interfaces is high, a dead zone develops where no material flow takes place. Also, in hot working, the material near the container walls cools rapidly and hence increases in strength; thus, the material in the central regions flows toward the die more easily than that at the outer regions. As a result, a large dead-metal zone forms, and the flow is inhomogeneous. Thus, the two factors that greatly influence metal flow in extrusion are the frictional conditions at billet-container - die interfaces and temperature gradients in the billet.

Mechanism of extrusion

The geometric variables in basic extrusion process are the die angle and the reduction ratio or extrusion ratio. Extrusion ratio is defined as the ratio of cross sectional area of the billet to the cross sectional area of the extruded product. The force required for extrusion depends on the strength of the billet material, the extrusion ratio, friction in the chamber and die, and process variables such as the temperature of the billet and speed of extrusion.

In direct extrusion, the effect of friction between the container walls and the billet causes the ram pressure to be greater than for indirect extrusion.

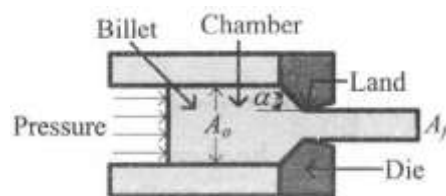

Fig 3.32: Extrusion parameters

Extrusion defects

Depending on material condition and process variables, extruded products can develop several types of defects, which can significantly affect their strength and product quality. There are three principal extrusion defects and are discussed below.

Surface cracking - If extrusion temperature, friction, or speed is too high, surface temperatures rise significantly may cause surface cracking and tearing. These cracks are inter-granular (along the grain boundaries). This situation can be avoided by lowering the billet temperature and extrusion speed. Surface cracking may also occur at lower temperatures. These cracks have been attributed to periodic sticking of the extruded product along the die land. Bamboo defects are periodic surface cracks that develop due to the extruded product sticking to the die land.

Pipe - Pipe defect occurs when the metal flow pattern draws surface oxides and impurities toward the centre of the billet, like a funnel. As much as one-third of the length of the extruded product may contain this type of defect and has to be cut off as scrap. Piping can be minimized by modifying the flow pattern to a more

uniform one, such as by controlling friction and minimizing temperature gradients.

Internal cracking - The center of the extruded product can develop cracks. These cracks are due to a state of hydrostatic tensile stress at the centerline in the deformation zone in the die. The tendency for center cracking increases with increasing die angle and amount of impurities and decreases with increasing extrusion ratio and friction.

Lubrication in extrusion

Lubrication is used, in manufacturing industry, to assist in metal flow over the work mould surfaces as a part is being extruded. Soaps, oils, graphite immersed in oil and many other special lubricants are all used in manufacturing industry to extrude parts. Some materials can be problematic in that they tend to stick to the tooling. To prevent sticking, a softer metal may be used for lubrication. In this case, the softer metal will be jacketed around the work. For manufacturing practice, particularly in high temperature processes, molten glass is often employed as an effective lubricant in the extrusion of tougher materials.

Advantages of extrusion

- 1) The tooling cost is low, as well as the cost due to material
- 2) Intricate cross sectional shapes, hollow shapes and shapes with undercuts can be produced.
- 3) The hardness and the yield strength of the material are increased.
- 4) In most applications, no further machining is necessary.

Limitations of extrusion

- 1) High tolerances are difficult to achieve.
- 2) The process is limited to ductile materials.
- 3) Extruded products might suffer from surface cracking. It might occur when the surface temperature rise due to high extrusion temperature, friction, or extrusion speed.
- 4) Internal cracking might also occur.

ROD, WIRE AND TUBE DRAWING

In the context of bulk deformation, drawing is an operation in which the cross section of a bar, rod, or wire is reduced by pulling it through a die opening. The general features of the process are similar to those of extrusion. The difference is that the work is pulled through the die in drawing, whereas it is pushed through the die in extrusion. Although the presence of tensile stresses is obvious in drawing, compression also plays a significant role because the metal is squeezed down as it passes through the die opening.

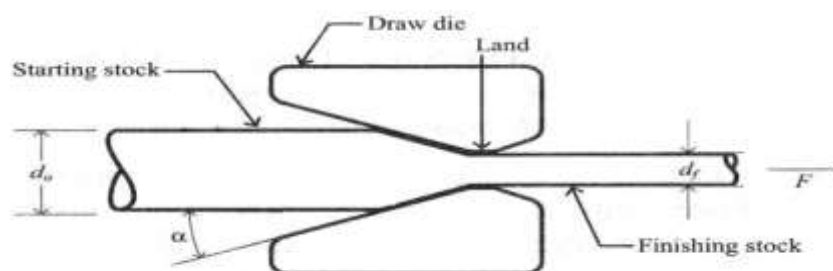

Fig 3.33: Rod drawing

The basic difference between bar drawing and wire drawing is the stock size that is processed. Bar drawing is the term used for large diameter bar and rod stock, while wire drawing applies to small diameter stock. Wire

sizes down to 0.03 mm are possible in wire drawing. Although the mechanics of the process are the same for the two cases, the methods and equipment are different.

Bar drawing is generally accomplished as a single-draft operation-the stock is pulled through one die opening. Because the beginning stock has a large diameter, it is in the form of a straight cylindrical piece rather than coiled. This limits the length of the work that can be drawn, necessitating a batch type operation. By contrast, wire is drawn from coils consisting of several hundred (or even several thousand) feet of wire and is passed through a series of draw dies. The term continuous drawing is used to describe this type of operation because of the long production runs that are achieved with the wire coils, which can be butt-welded each to the next to make the operation truly continuous.

WIRE DRAWING

Wire drawing process consists of pulling a wire through a die. Wire drawing is primarily the same as bar drawing except that it involves smaller - diameter material that can be coiled. It is generally performed as a continuous operation. Large coil of hot rolled material of nearly 10 mm diameter is taken and subjected to

preparation treatment before the actual drawing process. The preparation treatment for steel wire consists of cleaning (done by acid pickling, rinsing, and drying) and neutralization (any remaining acid on the raw material is neutralized by immersing it in a lime bath). To begin the drawing process, one end of coil is reduced in cross section up to some length and fed through the drawing die, and gripped.

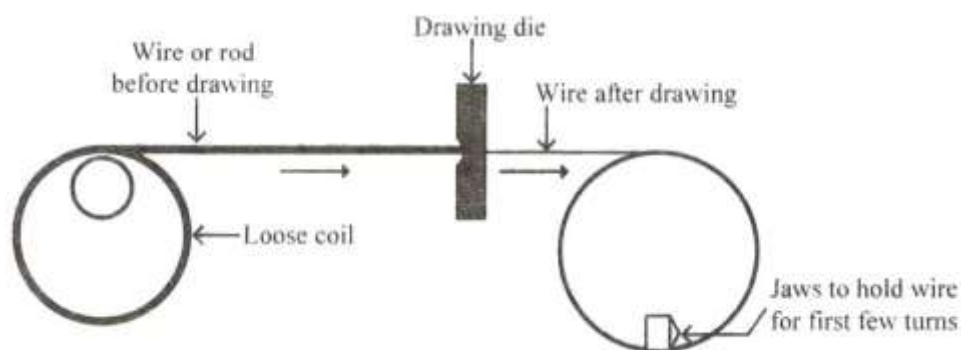

Fig 3.34: Wire drawing

A wire drawing die is generally made of tungsten carbide. Small diameter wire is generally drawn on tandom machines which consist of a series of dies, each held in a water - cooled die block. Each die reduces the cross section by a small amount so as to avoid excessive strain in the wire. Intermediate annealing of material between different states of wire may also be done.

TUBE DRAWING

The diameter and wall thickness of tubes that have been produced by extrusion or other processes can be reduced by tube drawing process. The process of tube drawing is similar to wire or rod drawing except that it usually requires a mandrel of the requisite diameter to form the internal hole. The simplest method uses no mandrel and is used for diameter reduction. The term tube sinking is sometimes applied to this operation. Hollow cylinders, pipes and tubes produced by techniques such as piercing, rolling etc are finished by tube drawing process. Rolling and extrusion process are used to form the actual tube shape from ingot or billet. Before carrying out drawing, tube surface is cleaned chemically, pickled (removing oxides) and washed in water and coated with lime and lubricants. Front end of the tube is tapered by cutting or squeezing. The tapered end is held by the gripper in the drawing carriage which moves with the help of an endless chain type

or hydraulic type draw-bench, thereby pulling the rod through the die.

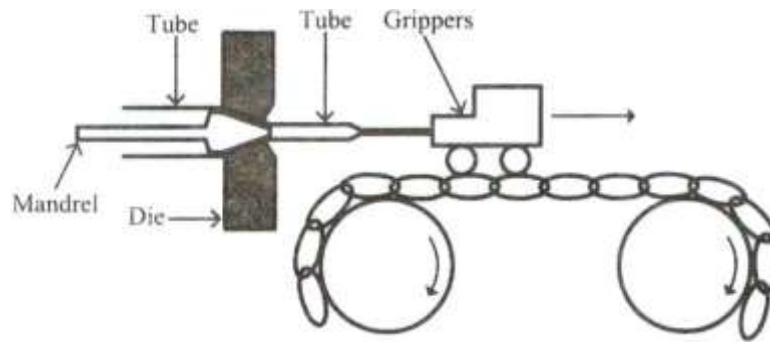

Fig 3.35: Tube drawing

Hypodermic needles are normally made from a stainless-steel tube through tube drawing process where the tube is drawn through progressively smaller dies to make the needle. The end is bevelled to create a sharp pointed tip letting the needle easily penetrate the skin.

Draw dies

A wire drawing die is generally made of tungsten carbide and for drawing very fine wire, diamond die is preferred. A typical draw die is shown in the figure. Four regions of the die can be distinguished.

Entry - The entry region is usually a bell-shaped mouth that does not contact the work. Its purpose is to funnel the lubricant into the die and prevent score of work and die surfaces.

Approach angle - The approach is where the drawing process occurs. It is coneshaped with an angle (half-angle) normally ranging from about 6° to 20° . The proper angle varies according to work material. **Bearing surface (land)** - The bearing surface, or land, determines the size of the final drawn stock.

Back relief - The back relief is the exit zone. It is provided with a back relief angle (half-angle) of about 30° . Draw dies are made of tool steels or cemented carbides.

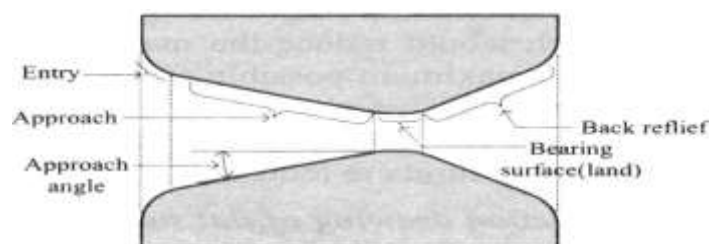

Defects that occur in metal drawing manufacture are similar to those that occur while manufacturing by extrusion. Controlling metal flow is essential in preventing defects.

Internal cracking- Internal breakage may occur in drawn products, particularly along the centerline. This is due to improper metal flow creating high internal stresses. Causes may be high die angles or low friction.

Surface defect - A wide variety-of surface defects can be observed in metal drawing manufacture. Seams (longitudinal scratches or folds in the material), scratches and cracks are all possible defects on the surface of drawn product.

LUBRICATION IN METAL DRAWING

Lubrication is an important factor when manufacturing by metal drawing, its application can help control the forces and metal flow. Lubrication will also extend the life of the mould, reduce temperature and improve surface finish. Different soaps and oils may be used as lubricants. With difficult to draw metals, polymers or soft materials may also be used as lubricants. The following are the basic methods of applying lubrication often employed.

Wet drawing - In wet drawing, the dies and the work are completely submersed in lubrication.

Dry drawing - In dry drawing, the surface of the rod to be drawn is coated with a lubricant by passing it through a box filled with the lubricant (stuffing box).

Metal coating- In metal coating, the rod or wire is coated with a soft metal, such as copper or tin that acts as a solid lubricant

Ultrasonic vibration of the dies and mandrels - In this process, vibrations reduce forces, improve surface finish and die life, and allow larger reductions per pass without failure.

MODULE-4

JIGS AND FIXTURES

Jigs and fixtures are special purpose tools which are used to facilitate production (machining, assembling and inspection operations) when machined products are to be produced on a mass scale. The mass production of work-pieces is based on the concept of interchangeability according to which every part will be produced within an established tolerance. Jigs and fixtures provide a means of manufacturing interchangeable parts since they establish a relation, with predetermined tolerances, between the work and the cutting tool. They are specially designed so that a large number of components can be machined or assembled identically, and to ensure interchangeability of components. They eliminate the necessity of a special set up for each individual part. Once a jig or fixture is properly set up, any number of duplicate parts may be readily produced without additional set up.

Jig

A jig is a device in which a component is held and located for a specific operation in such a way that it will guide one or more cutting tools to the same zone of machining. The usual machining operations for jigs are drilling and reaming. Jigs are usually fitted with hardened steel bushings for guiding drills or cutting tools. The most common jigs are drilling jigs, reaming jigs, assembly jigs, etc. When these are used, they are usually not fastened to machine tools or table but are free to be moved so as to permit the proper registering of the work and the tool. A simple drilling jig is shown in the figure. In the figure shown, the work-piece to be drilled is held and positioned in the drilling jig. Bushes guide the drills to the desired location(s) in the work-piece.

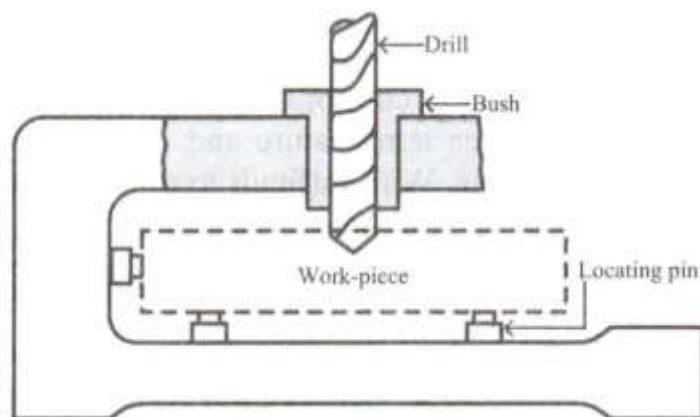

Fixture

A fixture is a production tool that locates, holds and supports the work securely in a fixed orientation with respect to the tool so that the required machining operations can be performed. The setting of the tool is done by machine adjustment and a setting block or by using slip gauges. A fixture is bolted or clamped to the machine table. It is usually heavy in construction. A simple fixture is shown in the figure. Fixtures vary in design from relatively simple tools to expensive complicated devices. These are most frequently attached to some machine tool or table. Consequently they are associated in name with the particular machine tool with which they are used, e.g., milling fixtures, broaching fixtures, assembly fixtures, etc. A fixture can be used in almost any operation that requires a precise relationship in the position of a tool to a work-piece.

Locating pins are stops or pins which are inserted in the body of jig or fixture, against which the work-piece is pushed to establish the desired relationship between the work-piece and the jig or fixture. To assure interchangeability, the locating elements are made from hardened steel. The purpose of clamping elements is to exert a force to press a work-piece against the locating elements and hold it there in opposition to the action

of the cutting forces. In the case of a jig, a hardened bushing is fastened on one or more sides of the jig, to guide the tool to its proper location in the work. However, in the case of a fixture, a target or set block is used to set the location of the tool with respect to the work-piece within the fixture. Most jigs use standard parts such as drill bushings, screws, jig bodies and many other parts. Fixtures are made from grey cast iron or steel by welding or bolting. Fixtures are usually massive bodies because they have to withstand large dynamic forces. Because the fixtures are in between the machine and the work-piece their rigidity and the rigidity of their fastening to the machine table are most important. Jigs are positioned or supported on the machine table with the help of feet which slide or rest on the machine table. If the drill size is quite large, either stops are provided or the jig is clamped to the machine table to withstand the high drilling torque. Fixtures are clamped or bolted to the machine table.

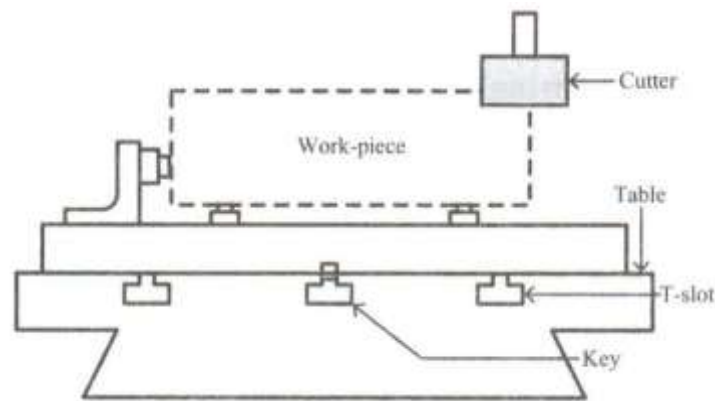

DIFFERENCES BETWEEN JIGS AND FIXTURES

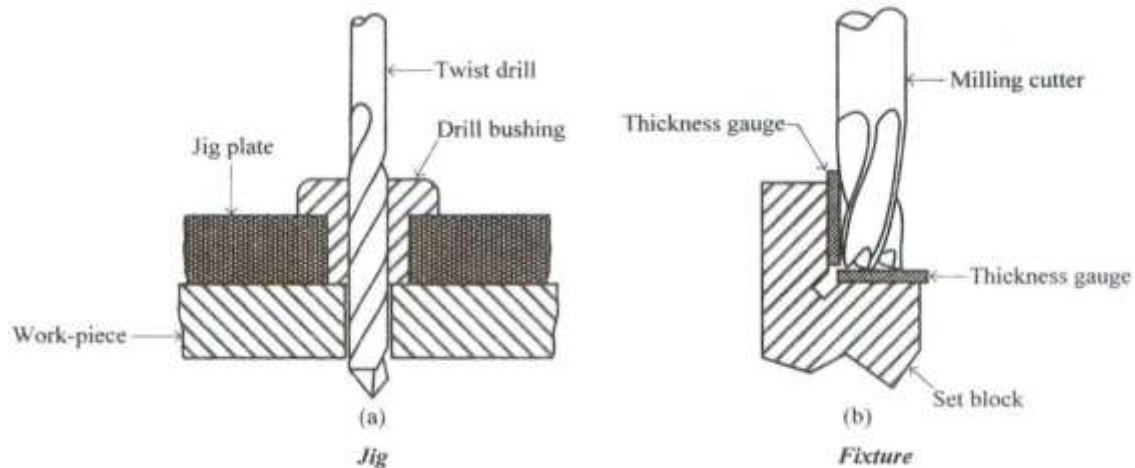

Often the terms 'jig' and 'fixture' are confused or used interchangeably; however, there are clear distinctions between these two tools. Both jigs and fixtures hold, support, and locate the work-piece. A jig, however, guides the cutting tool. A fixture references the cutting tool. The differentiation between these types of work-holders is in their relation to the cutting tool. As shown in the figure (a), jigs use drill bushings to support and guide the tool. Fixtures, figure (b) use set blocks and thickness, or feeler, gages to locate the tool relative to the work-piece.

Following are the differences between jigs and fixtures.

- 1) Essential difference between a jig and fixture is that the jig incorporates bushes that guide the tools whereas, the fixture holds the component being machined with the cutters working independently, of

it.

- 2) Jigs are used on drilling, reaming, tapping and counter boring operations, while fixtures are used in connection with turning, milling, grinding, shaping, planing and boring operations.
- 3) Whereas jigs are connected with operations, fixtures most commonly are related to specific machine tools.
- 4) Jigs are lighter than fixtures, for quick handling; fixtures are heavier in construction and bolted rigidly on the machine table.

Advantages of using jigs and fixtures

- 1) Jigs and fixtures provide easy means for manufacture of interchangeable parts and, thus, facilitate easy and quick assembly.
- 2) Reduced manufacturing costs (since large number of identical and interchangeable parts are produced) using jigs and fixtures.
- 3) Large reduction in fatigue to the operator (since there is considerable reduction in manual handling operations).
- 4) Complex and heavy components can be easily machined (since such parts can be rigidly held in proper location for machining in jigs and fixtures).
- 5) Owing to high clamping rigidity (offered by jigs and fixtures), higher speeds, feeds and depth of cut can be used and increased machining accuracy owing to the automatic location of the work and guidance of the tool.

Main components of jigs and fixtures

In order to fulfill their basic functions, both jigs and fixtures should process the following components or elements.

- 1) Sturdy and rigid body.
- 2) Locating elements.
- 3) Clamping elements.
- 4) Tool guiding elements (for jigs) or tool setting elements (for fixtures).
- 5) Positioning elements (these elements include different types of fastening devices).
- 6) Indexing elements (not always provided).

Degrees of freedom

A work-piece free in space can move in an infinite number of directions. For analysis, this motion can be broken down into twelve directional movements, or 'degrees of freedom'. Notice the 12 degrees of freedom consisting of 6 axial degrees of freedom and 6 radial degrees of freedom as shown in the figure. The axial degrees of freedom permit straight-line movement in both directions along the three principal axes, shown as X, Y, and Z. The radial degrees of freedom permit rotational movement, in both clockwise and counter clockwise radial directions, around the same three axes.

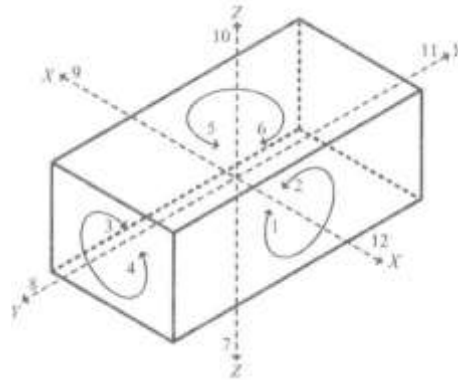

For accurate machining, the work-piece is to be placed and held in correct position and orientation in the fixture (or jig) which is again appropriately located and fixed with respect to the cutting tool (part of machine tool) and the machine tool (machine tool represent machine its self such as lathe, milling machine, etc., used to cut a metal in the desires shape). It has to be assured that the work-piece, once fixed or clamped, does not move at all. Any solid body may have maximum twelve degrees of freedom as indicated in the figure. By properly locating, supporting and clamping the blank it's all degrees of freedom are to be arrested as typically shown in the figure.

PRINCIPLES OF LOCATION

The term, '*location*' refers to the method of establishing correct relative position of the work-piece with respect to the cutting tool. In order to decide upon the location method, one has to consider the work-piece shape, surfaces and features that are likely to obstruct the tool movement or access direction. The correct positioning of the work-piece essentially requires restricting all the degrees of freedom of the work-piece. This is done with the help of locators, which must be strong enough to resist the cutting forces while maintaining the position of the work-piece. The basic principles of location are explained below.

- 1) **3-2-1 Principle**- A widely used method of restricting the 12 degrees of freedom is to uses the 3- 2-1 principle, so-called because it consists of three steps that employ three pins, then two pins, then one fixed pins of known location. Since that adds up to six fixed points, it's also known as the **six point location principle**. Application of 3-2- 1 principle generally gives rise to proper arresting of all the motions.

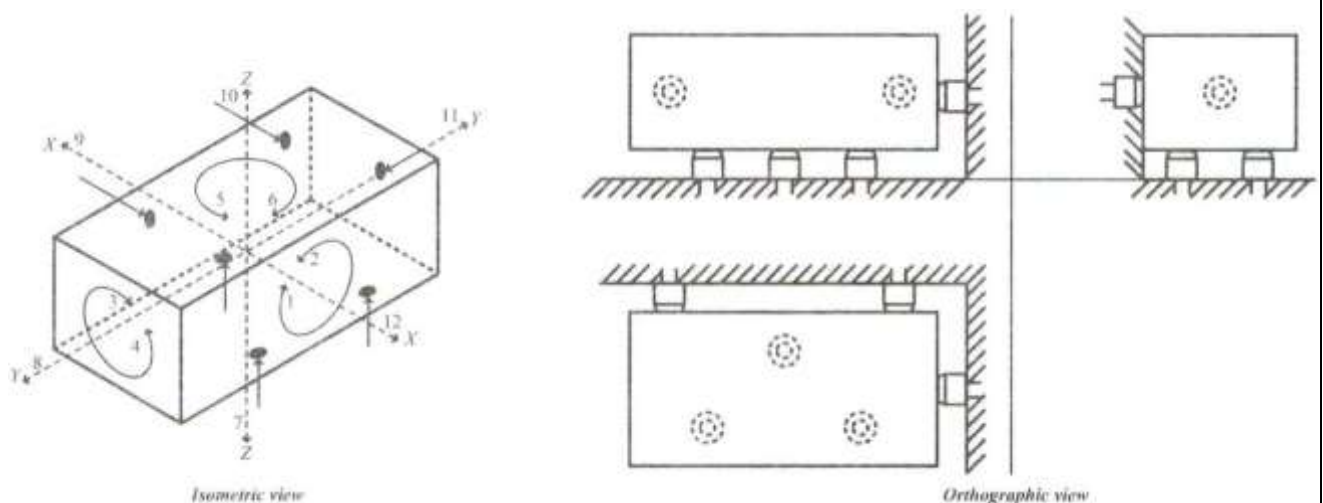

In 3-2-1 method, three pins are inserted in the base of the body restrict five motions viz., *1* and *2* rotation about the axis XX'' , *3* and *4* rotation about axis YY and downward motion *7* along Z axis. Inserting two more pins in a plane perpendicular to the plane containing the first three pins will restrict the rotation about Z axis (*5* and *6*) and also restrict the axial movement along X axis (degree of freedom *9*). Another pin is inserted in the vertical face of the body to restrict degree of freedom *11*.

Three degrees of freedom viz., **8**, **10** and **12** are still free. To restrict these three more pins are needed. But this will completely enclose the work-piece making its loading and unloading into jigs and fixture impossible. The rest three degrees of freedom are arrested by three external forces usually provided directly by clamping. This is the most common locating method employed for *square* or *rectangular parts*. The use of pin type locators offers more accuracy as the area of contact is less.

- 2) **The principle of mutually perpendicular planes** - An ideal location of a component is achieved when it is located on six locating points ('3- 2- 1 principle') in three mutually perpendicular planes. Other arrangements are possible but not desirable.
- 3) **Principle of least point** - In order to secure location in any one plane, points more than necessary should not be used. However, if more points are used such as for finished surface, the extra ones should only be inserted because they serve a useful purpose and care must be taken that they do not damage the location.
- 4) **Principle of extreme position** - On any one work-piece surface, locating points should be chosen as far apart as possible.

Locating methods

Depending upon the nature of surfaces to be located, most commonly methods of locating surfaces are explained below.

Locating from plane surfaces - The basic reference for locating is a flat plane, generally a machine table. The machine table is usually at right angles or parallel with the machines' feed movements. All locating devices are made with regard to the basic reference plane (machine table). If the work-piece has a flat side to mate with the machine table, the machine table becomes the locating surface.

If the work-piece does not have a flat side to mate with the machine table, the flat plane of the machine table cannot be used as a locating surface. A minimum of three points (or locators) must be used to locate the work-piece shown in the figure (b), although four or more may be used to provide adequate support. It should be noted that a minimum of three locators will always theoretically establish the same location of the work-piece. The number of adjustable supports would depend upon the shape, strength and size of the work-piece.

Locating from circular surfaces - The basic reference for locating from circular surfaces is the flat plane of the machine-tool table surface. However, instead of locating the flat plane of the work-piece parallel to the reference plane, it is necessary to locate the axis of the circular work-piece as shown in the figure.

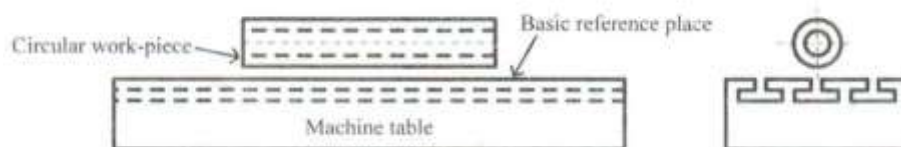

Circular work-piece must be located with its axis parallel with the basic reference plane.

One of the common methods of locating from a circular surface is by using cones, a method commonly referred to as conical location and usually employed when locating is done from a hole. Conical locators are used mainly to locate rough unmachined cylinders in castings and forgings.

Closely related to conical location is the V method, used primarily to locate round work-pieces or work-pieces with convex circular surfaces. It has been found that the best general V angle is 90° . Smaller included angles hold a round work-piece more securely but are more susceptible to location errors.

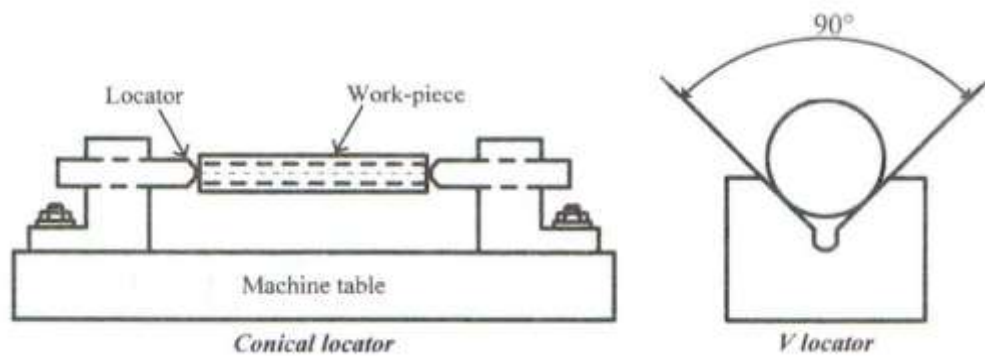

Concentric locating - Concentric locators locate a work-piece from its axis. This axis may or may not be in the center of the work-piece. The most-common type of concentric location is a locating pin placed in a hole.

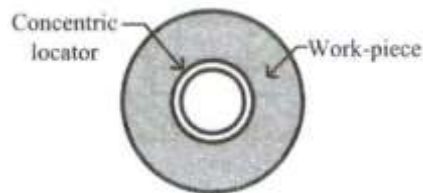

LOCATING DEVICES

There are several methods of locating; few of them are discussed below.

Locating blanks for machining in lathes - In lathes, where the job rotates, the blanks are located by the following methods.

- a) Fitting into self centering chuck.
- b) Fitting into 4- independent jaw chuck and dead centre.
- c) In self- centering collets.
- d) In between live and dead centres.
- e) By using mandrel fitted into the head stock - spindle.
- f) Fitting in a separate fixture which is properly clamped on a driving plate which is coaxially fitted into the lathe spindle.

Locating for machining other than lathes - In machine tools like drilling machine, boring machine, milling machine, planing machine, broaching machine and surface grinding machine the job remains fixed on the bed or work table of those machine tools. Fixtures are mostly used in the aforesaid machine tools and jig specially for drilling, reaming, etc. for batch production. For machining in those jigs and fixtures, the blank is located in several ways which include the followings.

1) Locating by flat surfaces

The figure typically shows locating jobs by their flat surfaces using various types of flat ended pins and buttons.

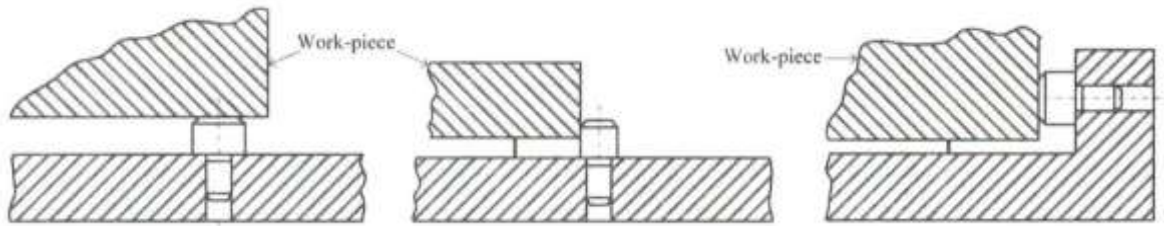

2) Locating by holes

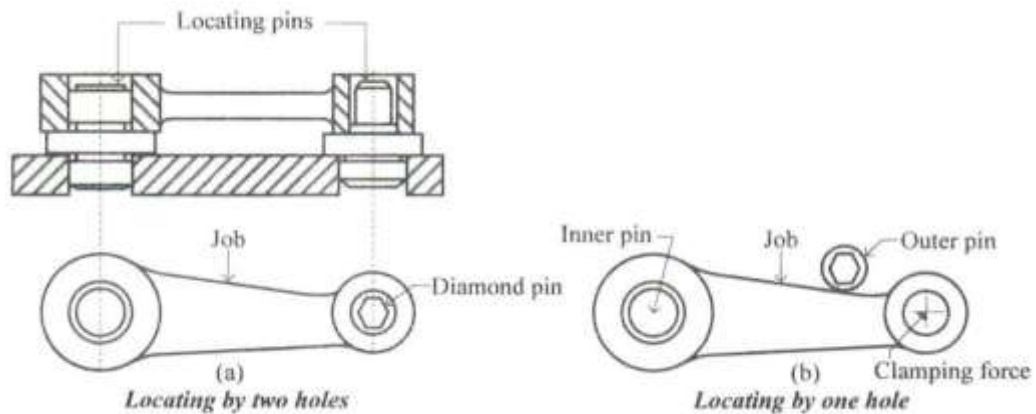

In several cases, work-pieces are located by pre-machined (drilled, bored or pierced) holes, such as below.

- i. Locating by two holes as shown in the figure (a) where one of the pins has to be diamond shaped to accommodate tolerance on the distance between the holes and their diameters.
- ii. Locating by one hole and an external pin which presents rotation of the blank around the inner pin as indicated in figure (b).

3) Locating on mandrel or plug

Ring or disc type work-pieces are conveniently located on mandrel or single plug as shown in the figure.

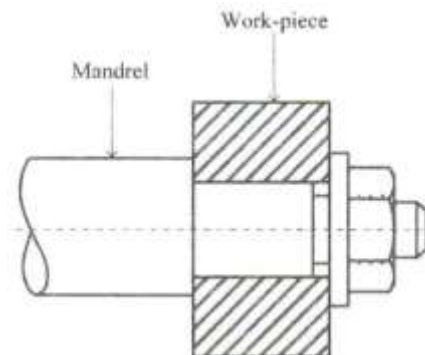

CLAMPING DEVICES

In jigs and fixtures, the work-piece or blank has to be strongly and rigidly clamped against the supporting surfaces and also the locating features so that the blank does not get displaced at all under the cutting forces during machining. A clamp is a device that holds the work-piece firmly against the locators provided and also resists all the forces generated by the cutting action of the tool on the work-piece. The most common example of a clamp is the bench vice, where the movable jaw of the vice exerts force on the work-piece thereby

holding it in the correct location in the fixed jaw of the vice. A clamping device ensures proper location and centering of the work-piece.

Basic requirements of clamping devices

1. To force the work-piece to remain in firm contact with locating pins or surfaces.
2. To rigidly hold the work-piece in a jig or fixture against all forces.
3. To exert just sufficient pressure on the work-piece.
4. To not to damage the work-piece it holds.

PRINCIPLES OF CLAMPING

While designing for clamping the following factors essentially need to be considered.

- 1) Clamping need to be strong and rigid enough to hold the blank firmly during machining.
- 2) Clamping should be easy, quick and consistently adequate.
- 3) Clamping should be such that it is not affected by vibration, chatter or heavy pressure.
- 4) The way of clamping and unclamping should not hinder loading and unloading the blank in the jig or fixture.
- 5) The clamp and clamping force must not damage or deform the work-piece.
- 6) Clamping operation should be very simple and quick acting when the jig or fixture is to be used more frequently and for large volume of work clamps.
- 7) Clamping system should comprise of less number of parts for ease of design, operation and maintenance.
- 8) The wearing parts should be hard or hardened and also be easily replaceable.
- 9) Clamping force should act on heavy part(s) and against supporting and locating surfaces.
- 10) Clamping force should be away from the machining thrust forces.
- 11) Clamping method should be fool proof and safe.

Types of clamps

The type of clamp to be used depends on the shape and size of the work-piece, the type of jig or fixture being used and the work to be done. There a number of clamps used by tool designers for clamping the work-piece properly. Different variety of clamps used with jigs and fixtures are classified into different categories are discussed below.

Strap clamp - Strap clamp are made of rectangular plates and act like levers. This type clamping is done with the help of the lever pressure acting as a strap on the workpiece.

Different types of strap clamps are discussed below.

- a) **Bridge clamp** - It is very simple and reliable clamping device. The clamping force is applied by the spring loaded clamping nut. The relative positions of the nut, the point of contact of the clamp with the work and with outer support should be carefully considered, since the compressive force of the nut is shared between the work-piece and the clamp support. To release the work-piece, the nut named as clamping nut is unscrewed. The spring lifts the lever to release the work-piece.

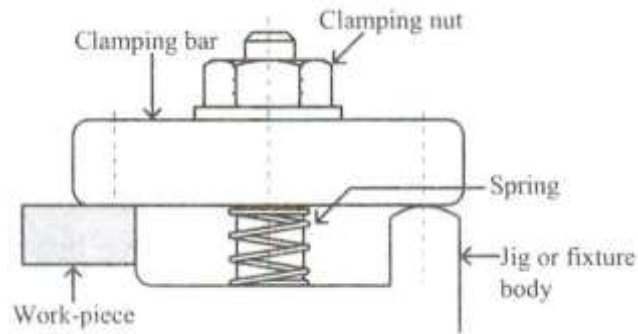

- b) **Heel clamp** - Heel clamp consist of strap, centre stud and a heel. The design differs from the simple bridge clamp in that a heel is provided in the outer end of the clamp to guide its sliding motion for loading and unloading the work-piece. By tightening the stud, the clamping force is transferred to the work-piece. Heel pin is the fulcrum about which the lever acts, while clamping force is applied at the stud by tightening the screw. The work-piece is loaded into the jig or fixture or removed from these, by unscrewing the clamping nut.

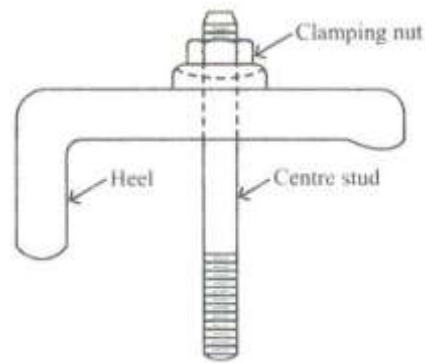

- c) **Swinging strap clamp**- Swinging strap clamp is a special type of clamp which provides a means of entry for loading and unloading the work-piece. For this, the strap can be swung out or in. A swing strap clamp is shown in the figure.

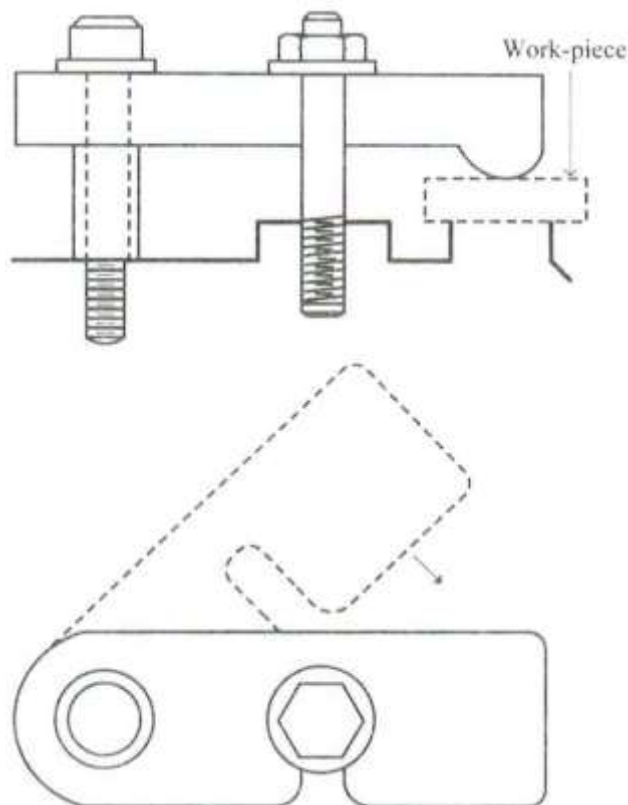

Side clamp - A side clamp is also known as edge clamp. In this case the surface to be machined is always clamped above the clamping device. This clamping device is recommended for fixed length work-piece. The clamping device is illustrated in the figure. Releasing and clamping of the work-piece can be accomplished by unscrewing and screwing of the clamping nut respectively.

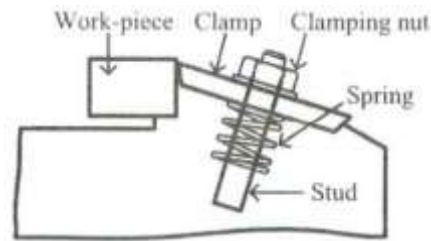

Hinged clamp - Several times, the requirement in a jig is that the strap (latch) should be completely lifted up for loading and unloading the work-piece. Hinged clamp has a hinged bolt and hinged strap/plate which when swung apart gives space to mount the workpiece. An example of hinged clamp is shown in the figure. The upper strap is locked on one side by means of the hinged bolt. This clamp provides rapid clearance for loading and unloading the work-piece.

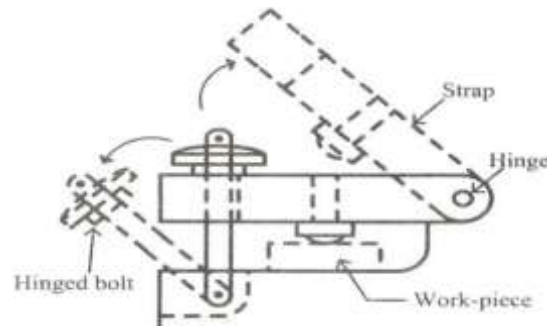

Vacuum clamping - Vacuum clamping is convenient for securing thin flat sheets which are vulnerable to distortion under heavy clamping force. Vacuum clamping provides light clamping. The holding face is provided with 0.025 mm deep grooves which serve as vacuum ducts. The clamping face is circumscribed by a rubber seal groove all around. The seal in the groove segregates the clamping vacuum area from the space outside the seal. The vacuum pressure is usually limited to 1 kg/cm . The figure shows a vacuum holding fixture, distribution grooves and rubber seal.

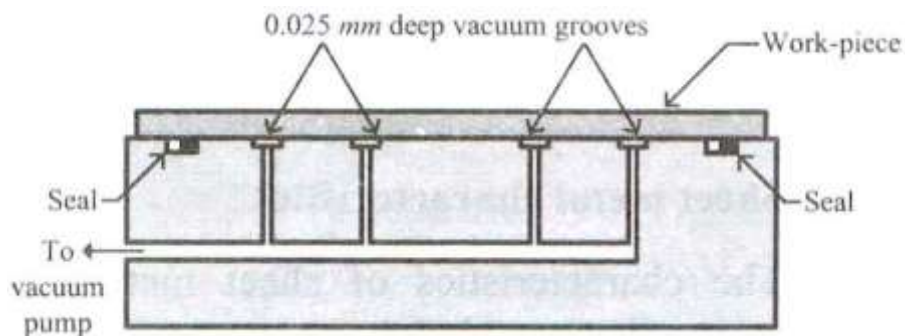

Magnetic clamping- Magnetic clamping uses electromagnetism for holding and is often used to hold ferrous metals or work-pieces made from other magnetic materials. It is independent of the component geometry to a certain degree. Magnetic clamping force can be developed by permanent magnets or electromagnets. In permanent magnet type, the work-piece to be clamped is placed on the work surface of the clamp. Below the working surface, there are a number of permanent magnets. When the lever is in 'ON' position, the magnetic flux passes through the work-piece to complete the magnetic circuit. When the lever is in 'OFF' position, the magnetic flux passes through the working surfaces of the clamp only and not through the work-piece, thus

unclamping the work-piece. This is done by aligning the magnets with a number of non-magnetic separators. In electromagnetic clamp, direct current is used for clamping the work-piece on electromagnetic devices. These magnets are more powerful than permanent magnet type clamps. Compared to other clamping methods, magnetic clamping is relatively weak. Magnetic clamping is widely used for grinding, and can be used for light milling and turning. It is fast and convenient.

SHEET METAL OPERATIONS

Sheet metal is generally considered to be a plate with thickness between 0.4 mm and 6 mm. There are numerous processes employed for making sheet-metal parts. However, the term press working or press forming is used commonly in industry to describe general sheet forming operations, because they typically are performed on presses using a set of dies. Press working makes use of large forces by press tools for a short interval of time for cutting or shaping the metals. Close dimensionally accuracy can be obtained with press working. A sheet metal part produced in presses is called a stamping. Low-carbon steel is the most commonly used sheet metal because of its low cost and generally good strength and formability characteristics. Most manufacturing processes involving sheet metal are performed at room temperature. Sheet metal operations done on a press can be classified into two.

Cutting operation - In cutting operation the stress applied is more than ultimate strength (maximum stress a material can sustain without fracture). eg. blanking, punching, etc. The stresses caused in the metal by the applied forces is shearing stress.

Forming operation- In forming operation, the stress applied is less than the ultimate strength. In this, there is no cutting of the metal, but only the contour of the work-piece is changed to get the desired product. eg. bending, drawing, etc. The stresses induced in bending and drawing is tensile and compressive.

MODULE V

SHEET METAL CHARACTERISTICS

The characteristics of sheet metals that have important effects on the forming operations are discussed below.

Elongation - A specimen subjected to tension first undergoes uniform elongation and when the load exceeds the ultimate tensile strength of the material, the specimen begins to neck and thus elongation is no longer uniform. Because the material usually stretched in sheet forming, high uniform elongation is desirable for good formability.

Yield-point elongation - Low-carbon steels and some aluminum-magnesium alloys exhibit a behavior called yield-point elongation. This behavior results in Luder's bands (also called stretcher-strain marks) on the sheet. These are elongated depressions on the surface of the sheet. The usual method of avoiding Luder's bands is to reduce the thickness of the sheet 0.5 to 1.5% by cold rolling. Because of strain aging, however, the yield point elongation reappears after a few days at room temperature or after a few hours at higher temperatures. To prevent this undesirable occurrence, the material should be formed within a certain time limit after rolling.

Anisotropy - An important factor that influences sheet-metal forming is anisotropy (directionality) of the sheet. Anisotropy is acquired during the thermo-mechanical processing of the sheet. There are two types of anisotropy viz., crystallography anisotropy (preferred orientation of the grains) and mechanical fibering (alignment of impurities, inclusions, and voids throughout the thickness of the sheet).

Grain size - Grain size affects mechanical properties and influences the surface appearance of the formed part. The smaller the grain size, the stronger is the metal.

Dent resistance of sheet metals - Dent resistance of sheet-metal parts has been found to (a) increase as the sheet thickness and its yield stress increase and (b) decrease as its elastic modulus and its overall panel stiffness increase. Consequently, panels rigidly held at their edges have lower dent resistance because of their higher stiffness.

Wrinkling- Wrinkling in the wavy condition on metal parts, due to buckling under compressive stresses. Wrinkling can be controlled by proper tool and die design.

Spring-back - Because all materials have a finite modulus of elasticity, plastic deformation always is followed by some elastic recovery when the load is removed. In bending, this recovery is called spring-back, which can be observed easily by bending and then releasing a piece of sheet metal or wire. Spring-back can be controlled by techniques such as over-bending and bottoming of the punch.

TYPICAL SHEARING

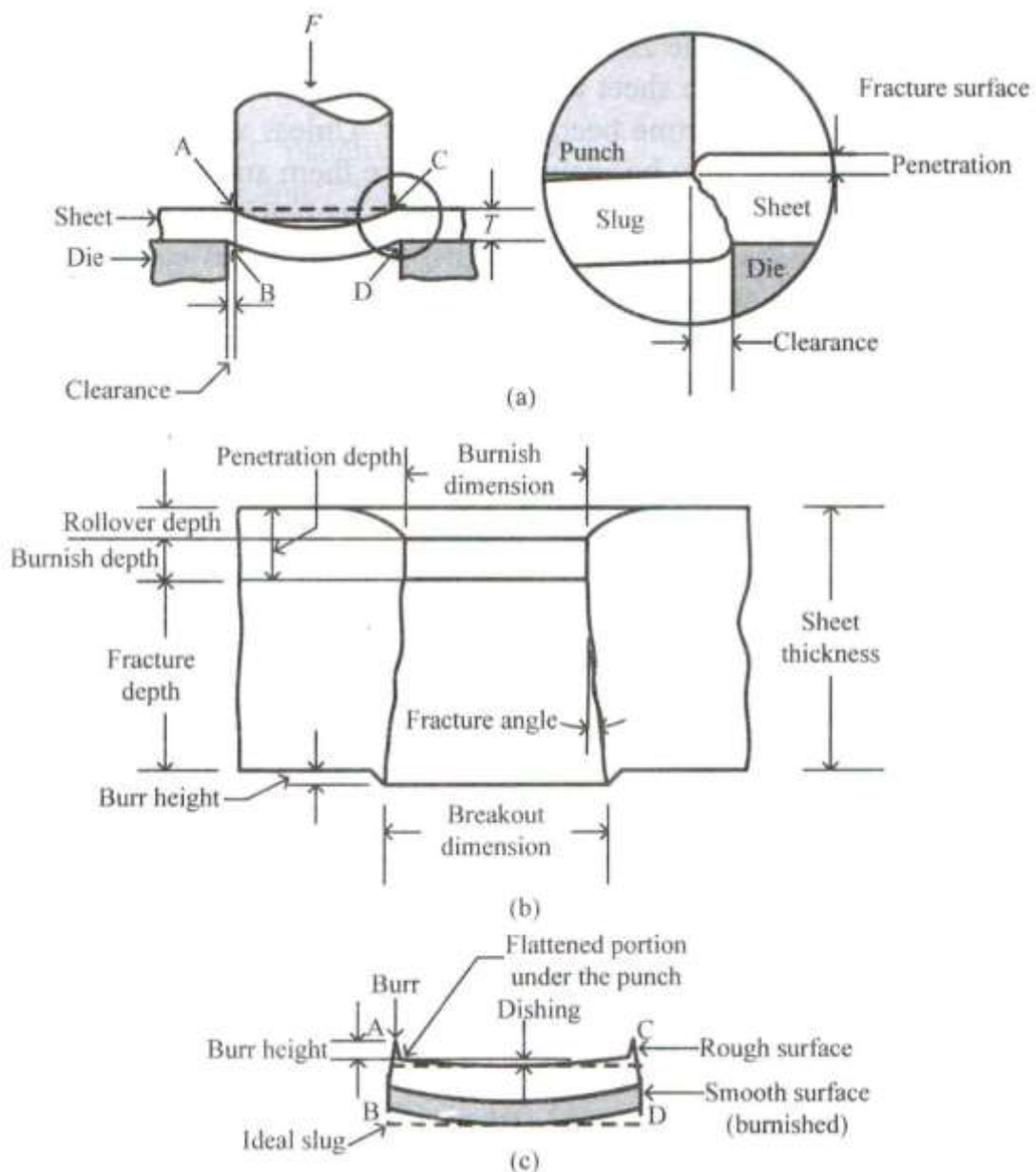

Typical shearing

Before a sheet-metal part is made, a blank of suitable dimensions first is removed from a large sheet (usually from a coil) by shearing. This sheet is cut by subjecting it to shear stresses, generally using a punch and a die. The typical features of the sheared edges of the sheet and of the slug are shown in the figure (a), (b) and (c) respectively. Note that the edges are not smooth nor are they perpendicular to the plane of the sheet. Shearing generally starts with the formation of cracks on both the top and bottom edges of the work-piece (at points A and B, and C and D, in the figure (a)). These cracks eventually meet each other and complete separation occurs. The rough fracture surfaces are due to the cracks; the smooth and shiny burnished surfaces on the hole and the slug are from the contact and rubbing of the sheared edge against the walls of the punch and die, respectively. The major processing parameters in shearing are:-

1. The shape of the punch and die,
2. The speed of punching,
3. Lubrication and
4. The clearance between the punch and the die.

The clearance is a major factor in determining the shape and the quality of the sheared edge. As the clearance increases, the zone of deformation (figure (a)) becomes larger and the sheared edge becomes rougher. The sheet tends to be pulled into the clearance region, and the perimeter or edges of the sheared zone become rougher. Unless such edges are acceptable as produced, secondary operations may be required to make them smoother (which will increase the production cost). Edge quality can be improved with increasing punch speed; speeds may be as high as 10 to 12 m/s. As shown in figure (b), sheared edges can undergo severe cold working due to the high shear strains involved. Work hardening of the edges then will reduce the ductility of the edges and thus adversely affect the formability of the sheet during subsequent operations, such as bending and stretching. The ratio of the burnished area to the rough areas along the sheared edge (a) increases with increasing ductility of the sheet metal and (b) decreases with increasing sheet thickness and clearance. The extent of the deformation zone depends on the punch speed. With increasing speed, the heat generated by plastic deformation is confined to a smaller and smaller zone. Consequently, the sheared zone is narrower, and the sheared surface is smoother and exhibits less burr formation. A burr is a thin edge or ridge, as shown in figure (b) and (c). Burr height increases with increasing clearance and ductility of the sheet metal. Dull tool edges contribute greatly to large burr formation. The height, shape, and size of the burr can significantly affect subsequent forming operations.

PUNCHING FORCE

The force required to punch out a blank is basically the product of the shear strength of the sheet metal and the total area being sheared along the periphery.

As the clearance increases, the punch force decreases, and the wear on dies and punches also is reduced.

PRESS WORKING DIES

Press working dies can be classified on the basis of method of operation as single operation dies, compound dies, combination dies, gang and follow dies, progressive dies and forming dies.

Single operation dies

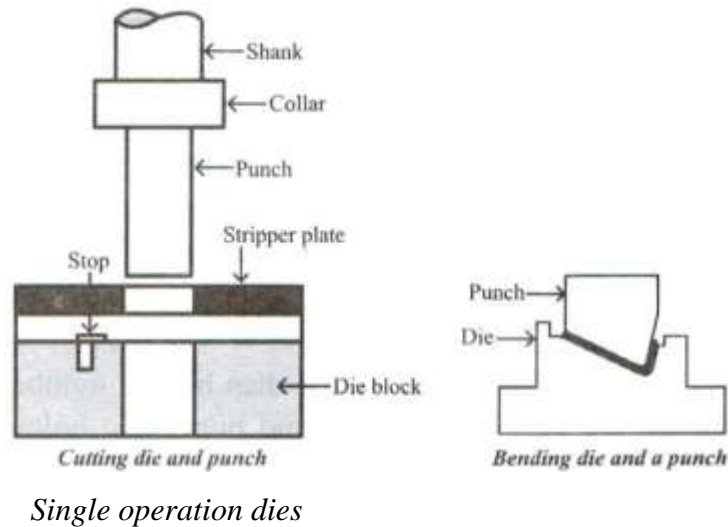

Simple dies or single operation dies only single operation can be carried out in one stroke. According to the functions performed by die, the single operation die may be either a cutting die for cutting or shearing blanks or a forming die which changes the shape of die blank but without removing any stock, for example bending and drawing dies.

Compound dies

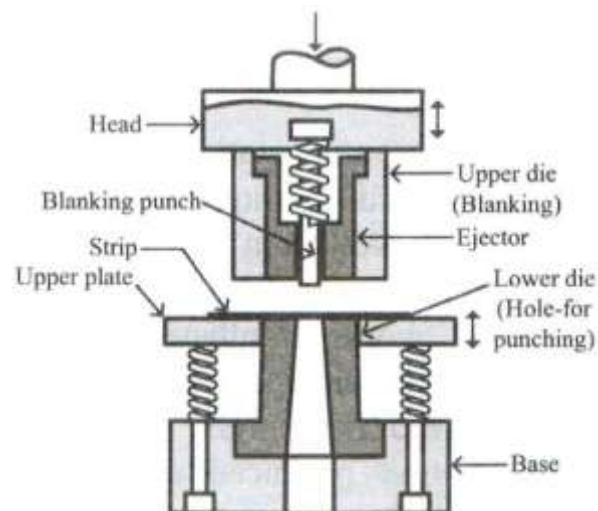

Compound dies

Compound dies are usually used for blanking and punching operations. Both blanking and punching operations can be carried out in one stroke. The figure illustrates a simple compound die in which a washer is made by one stroke of the press. The washer is placed by simultaneous punching and blanking of the die. The metal sheet is placed between the upper and the lower die. Stripper plate is used for removal of finished metal piece from the die. Several operations on the same sheet may be performed in one stroke at one station with a compound die. Such combined operations usually are limited to relatively simple shapes, because (a) the process is somewhat slow and (b) the dies rapidly become much more expensive to produce than those for

individual shearing operations, especially for complex dies.

Combination dies

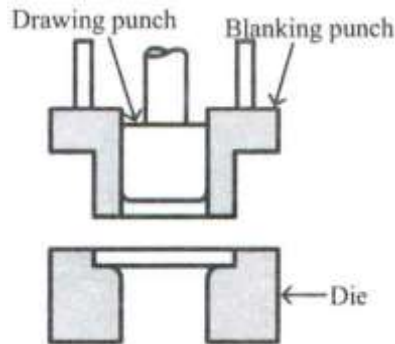

Combination dies

In combination die also more than one operation can be performed in one station. Combination die differs from compound die in the sense that a cutting operation is combined with bending or drawing operation. Combination is a single station die, but a double action press is used. A combination die is shown in the figure. In this during operation, the blanking operation is carried out initially and then blanking punch act as the blank holder during which drawing punch descends to do the drawing operation. So, in a combination die a cutting operation is combined with a non-cutting operation. The cutting operations may include blanking, piercing, trimming, etc., and are combined with non-cutting operations which may include bending,

extruding, embossing and forming.

Gang and follow dies

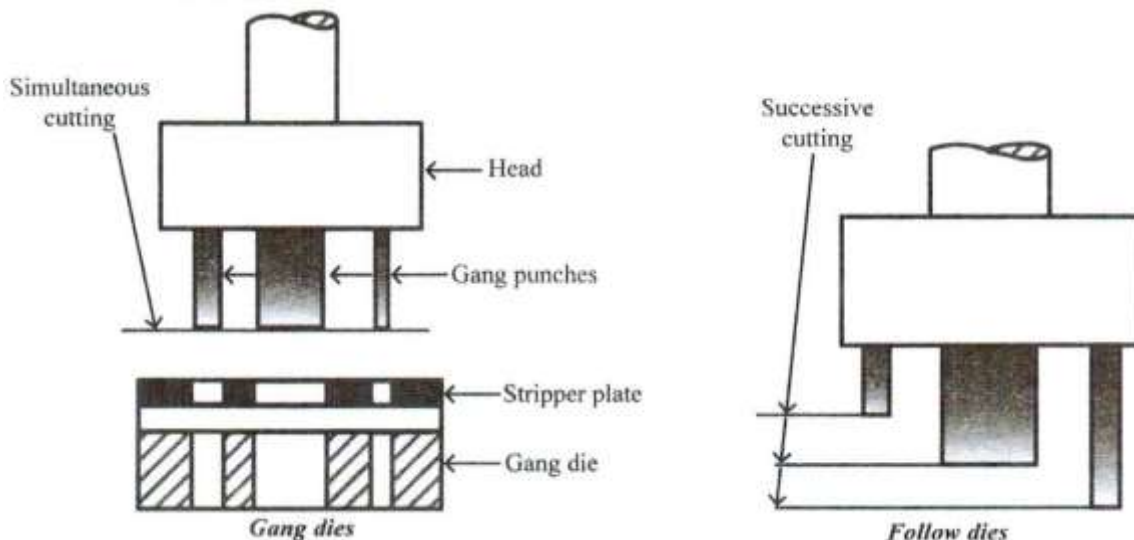

Gang and follow dies

Both gang and follow dies have a number of dies in a single punching head. In gang die all the punches descend and punch the holes simultaneously. A follow die is a modified gang die in which all the punches do not operate at the same time; Punching will be done one by after the other.

Progressive dies

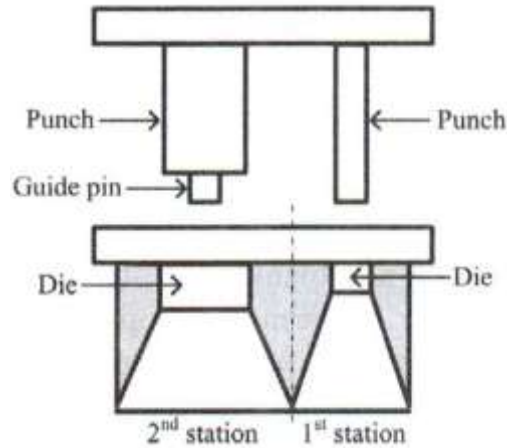

Progressive dies

It is a multi station die. In this type, workpiece is allowed to move through the die. As the work-piece moves from one station to another, with separate operation will be performed at each station. All station work simultaneously. Figure shows a progressive die for producing a washer. As the metal strip is moved from right to left, the hole for the washer is first produced and then the washer is blanked from the strip.

Transfer dies

Unlike progressive dies, where the stock is fed progressively from one station to another, in transfer dies, the already cut blanks are fed mechanically from station to station. Elimination of scrap is the main advantage of transfer dies over progressive dies.

Forming dies

It consists of a male and a female template held in punch holder. Sheet is kept between the male and female template.

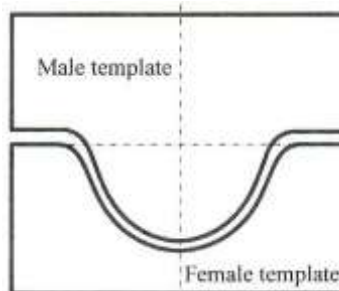

Forming dies

PRESS WORKING OPERATIONS

A press working operation involves application of large forces by press tools to cut or shape the sheet metal. The press working operation is generally completed in one stroke of the press and often results in the production of a finished part in less than one second. Press working operations may be classified as follows.

1. Cutting or shearing operations
 - a. Blanking
 - b. Punching
2. Bending operation

- a. Angle bending
- 3. Forming operation
 - a. Stretch forming
 - b. Shear spinning
 - c. Tube spinning
- 4. Drawing operations
 - a. Deep drawing
 - b. Redrawing
- 5. Reducing operation
 - a. Ironing

Blanking

Blanking is the operation of cutting a shape from a metal strip. The piece detached from the strip is called blank. The remaining metal strip is called scrap. Setup consists of a punch and a blanking die. Blanking die must have a clearance; otherwise blank would not fall freely. Fine blanking is a specialized form of blanking where there is no fracture zone when shearing. Fine-blanking process produces precision blanks in a single operation, without the fracture edges characteristically produced in conventional blanking. The process eliminates the need for in-process secondary operation. A specially shaped blank holder (V-shaped impingement ring) is forced into the stock, to lock it tightly against the die, just prior to the beginning of the cut. The material being sheared is not structurally separated, until the punch has fully penetrated the stock thickness. This results in the production of precise blanks. Die clearance is extremely small and punch speed is much slower than in conventional blanking. A counter punch operates with the main punch, eliminating any curvature of the part.

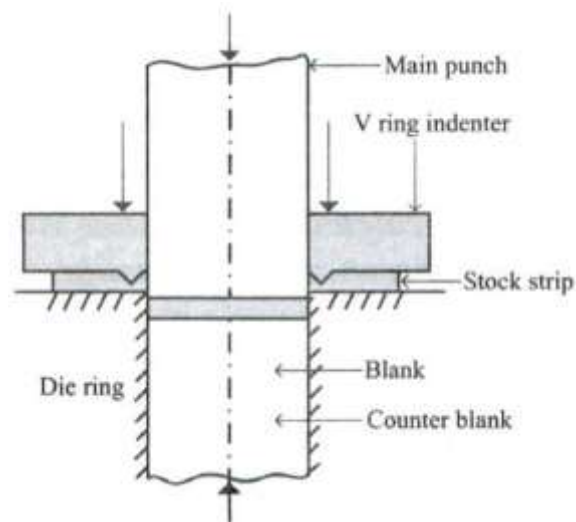

Fine blanking

The process of fine blanking is completed in the following steps.

1. The stock to be blanked is held against die-ring, with the help of the V -ring indenter.
2. The stock is then pressed by a counter punch against the main blanking punch, and the two punches move downwards.
3. After shearing, main blanking punch and impingement ring move upward. Simultaneously, counter punch moves upwards and ejects the blank out of the die-ring.

Punching

Punching is a process of producing a hole in a metal piece using a punch and a die. Metal with the hole is the required product and part removed is the scrap (slug).

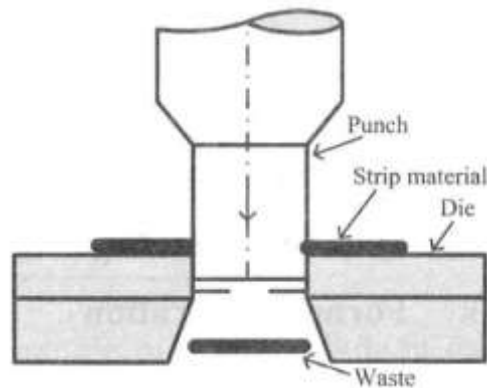

Punching

In blanking, the blank is the useful product and in punching, the punched sheet in which hole has been made is the required product. In punching clearance is provided on die while in blanking clearance is provided on punch. The shear angle is provided on die in blanking, and on punch in punching. The die opening must be sufficiently larger than the punch to allow a clear fracture of metals. The difference in sizes of the die opening and punch is known as clearance. The correct clearance depends on sheet-metal type and thickness t .

If the clearance is not set correctly, either an excessive force or an oversized defect can occur. The calculated clearance value must be subtracted from the die punch diameter for blanking operations and must be added to die hole diameter for punching. Die diameter is enlarged with clearance c in punching. In blanking, the punch diameter is decreased to account for clearance. D is the nominal size of the final product.

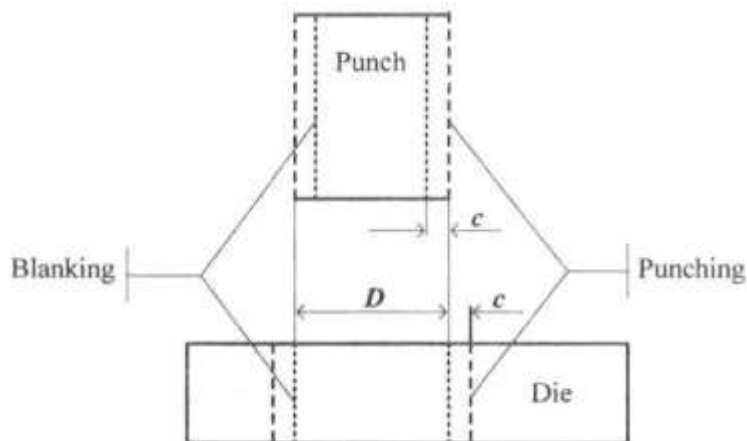

Blanking

$$\text{Blanking punch diameter} = D - 2c$$

Punching

$$\text{Hole die diameter} = D + 2c$$

Clearance in blanking and punching

Bending

Bending is a process by which a straight metal is worked into a curved length. It is a non cutting operation. It is used to manufacture trays, boxes, brackets, clips, etc. Bending requires a press tool to deform a component

permanently to a required shape. The work is bent by placing it on the die and then forcing the punch on it so as to take the shape between the die and the punch.

Bending terminology

A bend can be characterized by several different parameters, as shown in the figure.

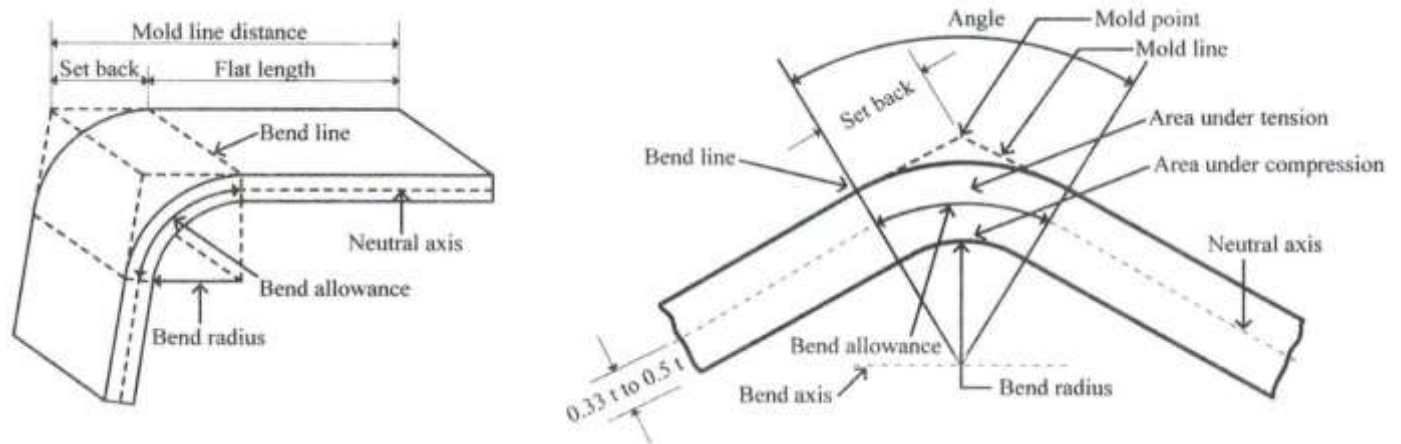

Bending terminology

Bend line - The straight line on the surface of the sheet, on either side of the bend, that defines the end of the level flange and the start of the bend.

Outside mold line - The straight line where the outside surfaces of the two flats would meet, were they to continue. This line defines the edge of a mold that would bound the bent sheet metal.

Flat length - The length of either of the two flats, extending from the edge of the sheet to the bend line.

Mold line distance - The distance from either end of the sheet to the outside mold line.

Setback - The distance from either bend line to the outside mold line. Also equal to the difference between the mold line distance and the flat length.

Bend axis - The straight line that defines the centre around which the sheet metal is bent.

Bend length - The length of the bend, measured along the bend axis.

Bend radius - The distance from the bend axis to the inside surface of the material, between the bend lines. Sometimes specified as the inside bend radius (R). The outside bend radius is equal to the inside bend radius plus the sheet thickness.

Bend angle - The angle of the bend, measured between the bent flange and its original position, or as the included angle between perpendicular lines drawn from the bend lines.

During bending operation, the outer surface of the material is in tension and inside surface is in compression. So the outer surface of the material increases in length and inner surface of the material reduces in length. The neutral axis is the boundary line inside the sheet metal, along which no tension or compression forces are present. As a result, the length of this axis remains constant. The changes in length of the outside and inside surfaces can be related to the original flat length by two parameters, the bend allowance and bend deduction.

Neutral axis - The location in the sheet that is neither stretched nor compressed, and therefore remains at a constant length.

K-factor - The location of the neutral axis in the material, calculated as the ratio of the distance of the neutral axis (measured from the inside bend surface) to the material thickness. The K-factor is dependent upon several factors (material, bending operation, bend angle, etc.) and is typically greater than 0.25, but cannot exceed 0.50.

Bend allowance -The length of the neutral axis between the bend lines, or in other words, the arc length of the bend. The bend allowance added to the flat lengths is equal to the total flat length.

Bend deduction- Also called the bend compensation, the amount a piece of material has been stretched by bending. The value equals the difference between the mold line lengths and the total flat length.

BEND ALLOWANCE

To calculate the blank length for bending, the length of material in the curved section or bend area has to be calculated. This length in the bend area which will be more than the corresponding length of blank before bending, is called bend allowance. The bend allowance added to the lengths of the straight legs of the part will give the length of blank. The bend allowance describes the length of the neutral axis between the bend lines, or in other words, the arc length of the bend. The bend allowance varies with the distance of the neutral axis from the inside surface of the bend.

MINIMUM BEND RADIUS

The radius of the corner must not be too small, otherwise, material will crack on outside. Bend radius is defined as the radius of curvature on the inside or concave surface of the bend. To prevent the cracking of the material on the outer tensile surface, the bend radius cannot be made smaller than a certain value. Very ductile materials can have zero bend radius i.e., they can be folded upon themselves. However, to prevent any damage to the punch and die, the bend radius should not be less than 0.8 mm. In general, soft metals can be bent 180° with a radius equal to or less than the stock thickness. The bend radius must be larger and angle less for metals of high temper. For such materials, the bend radius is kept equal to or greater than five times the stock thickness. For magnesium the bend radius may be up to 20 times the stock thickness.

The bend radius usually is expressed in terms of the thickness, such as $2t$, $3t$, $4t$, and so on. Thus, a $3t$ minimum bend radius indicates that the smallest radius to which the sheet can be bent without cracking is three times its thickness. There is an inverse relationship between bendability and the tensile reduction of the area of the material.

BENDABILITY

Bendability is the property of a metal being easily bent without breaking. The bendability of sheet metals decreases as their thickness increases. Also, the minimum bend radius, R , is, can be expressed approximately as below.

Thus, for $r = 50$, the minimum bend radius is zero; that is, the sheet can be folded over itself in much the same way as a piece of paper is folded. To increase the bendability of metals, we may increase their tensile reduction of area either by heating or by bending in a high-pressure environment (which improves the ductility of the material). Bendability also depends on the edge condition of the sheet. Since rough edges are points of stress concentration, bendability decreases as edge roughness increases.

BENDING FORCE

The bending force for sheets and plates can be estimated by assuming that the process is one of simple bending of a rectangular beam. Thus, the bending force is a function of the strength of the material, the length, L , of the bend, the thickness, t , of the sheet, and the die opening, w .

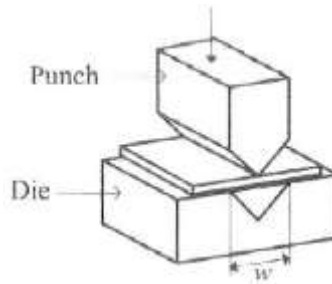

Bending force

The force in die bending varies throughout the bending cycle. It increases from zero to a maximum, and it may even decrease as the bend is completed. The force then increases sharply as the punch reaches the bottom of its stroke and the part touches the bottom of the die.

SPRING BACK

At the end of the bending operation, when the pressure on the metal is released, there is an elastic recovery of the metal causing decrease in the bend angle. Such metal movement is called as spring back. Spring back is the extent to which a metal return to its original shape or position after undergoing a bending or forming operation. This causes a decrease in the bend angle. For low carbon steel, it can be 1° to 2° and for medium carbon steel, it can be 3° to 4° . Harder metals have more degree of spring back. Softer metals have lesser degrees of spring back. Smaller bend radius causes more degrees of spring back. More degrees of bend cause more degrees of spring back. In V -die bending, it is possible for the material to also exhibit negative spring back caused by the nature of the deformation at the end of the stroke.

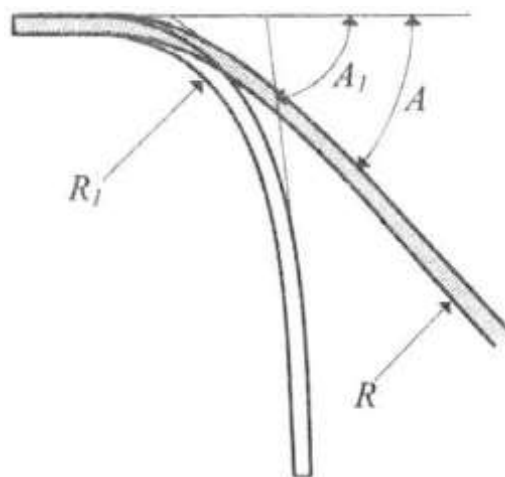

Spring back

METHODS OF PREVENTING SPRING BACK

Methods used to overcome or prevent spring back are discussed below.

Over bending - The piece is over bent so that it will have proper angle. Over bending may be accomplished by setting the bending punch and die at a smaller angle than required.

Bottoming - Bottoming consists of striking the metal severely at the radius area. This places the metal under high compressive strains that set most of the metal past the yield point and hence the spring back is avoided.

Stretch forming - Stretch forming consists of stretching the blank so that all the metal is past the elastic limit. The metal is then forced over the punch to obtain the desired contour.

Ironing- Spring back can be prevented by wiping dies by ironing the material. To iron the bend effectively, the distance between the punch and die must be slightly less than the metal thickness.

BENDING METHODS

The two methods commonly used are V-bending and edge bending.

V-bending

In V -bending, a wedge shaped punch forces the metal into the die cavity. The bend angle may be acute, 90° , or obtuse. As the punch descends, the contact forces at the die corner produce a sufficiently large bending moment at the punch corner to cause the necessary deformation. In V -bending, a simple punch and die that each has the included angle are used to bend the part. V -bending is generally used for low production operations.

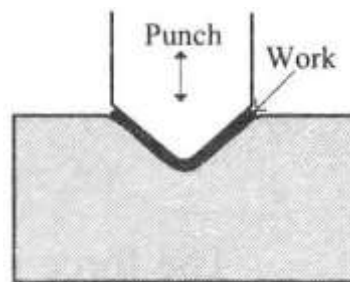

V-bending

Edge bending

In edge bending, a flat punch forces the metal piece against the vertical face of the die. The bend axis is parallel to the edge of the die and the stock is subjected to cantilever loading. To prevent the movement of stock during bending, it is held down by a pressure pad. Edge bending gives a good mechanical advantage when forming a bend.

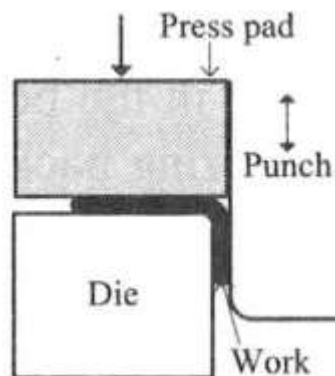

Edge bending

Air bending

Air bending is a simple method of creating a bend without the need for lower die geometry. In air bending, the sheet metal is supported by two surfaces a certain distance apart. A punch exerts force at the correct spot, bending the sheet metal between the two surfaces.

PRESS-BRAKE FORMING

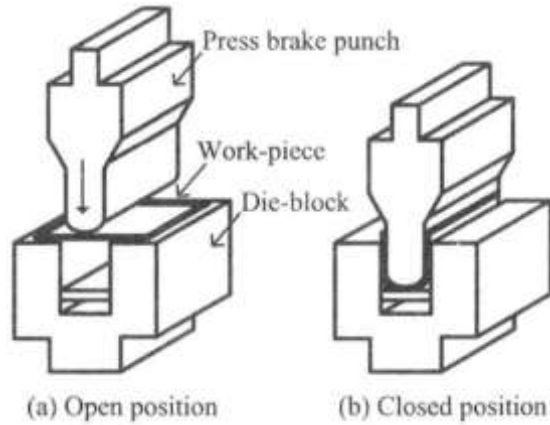

Press brake forming

Sheet metal or plate can be bent easily with simple fixtures using a press. Sheets or narrow strips that are 7 m or even longer usually are bent in a press brake. The machine utilizes long dies in a mechanical or hydraulic press and is particularly suitable for small production runs. In press brake forming, the work-piece is positioned over the die block and formed by the punch as it is forced into the die cavity. Although a secondary press motion may be required to compensate for material spring back, many dies are designed to 'overbend' the part and automatically compensate for material spring back. The punch and die used on a press brake can be changed. As can be seen in the figure, the tooling is simple, their motions are only up and down, and they easily are adaptable to a wide variety of shapes. Also, the process can be automated easily for low-cost, high-production runs. Die materials for press brakes range from hardwood (for low-strength materials and small-production runs) to carbides for strong and abrasive sheet materials and also are chosen to improve die life. For most applications, however, carbon-steel or gray-iron dies generally are used. Materials commonly used in the brake forming process include, aluminum, brass, cold rolled, carbon steel, hot rolled carbon steel, stainless steel, etc. The press braking process can produce a variety of shapes. Some of the common shapes produced by press brake forming are illustrated two-dimensionally.

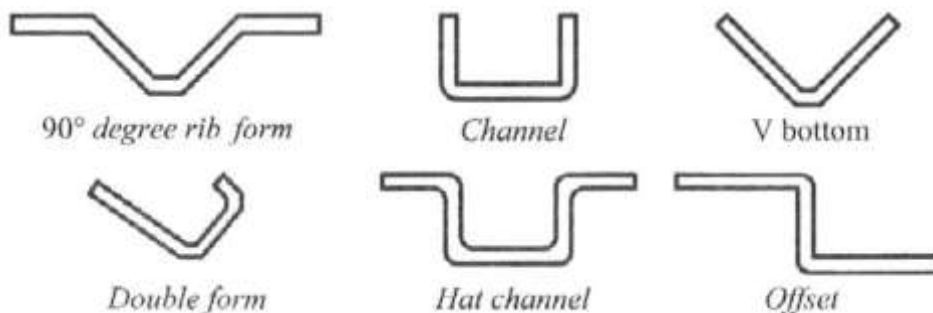

Common shapes produced by press brake

TUBE BENDING

There are several methods of producing tubes and pipes. In this section, we examine methods by which tubes are bent and otherwise formed. Some of the terms in tube bending are defined in the figure shown. The radius

of the bend, R is defined with respect to the centre line of the tube. When the tube is bent, the wall on the inside of the bend is in compression, and the wall at the outside is in tension. These stress conditions cause thinning and elongation of the outer wall and thickening and shortening of the inner wall. As a result, there is a tendency for the inner and outer walls to be forced toward each other to cause the cross section of the tube to flatten. Because of this flattening tendency, the minimum bend radius R that the tube can be bent is about 1.5 times the diameter D when a mandrel is used and 3.0 times D when no mandrel is used. The exact value depends on the Wall Factor (WF), which is the diameter D divided by wall thickness t . Higher values of WF increase the minimum bend radius; that is, tube bending is more difficult for thin walls. Ductility of the work material is also an important factor in the process.

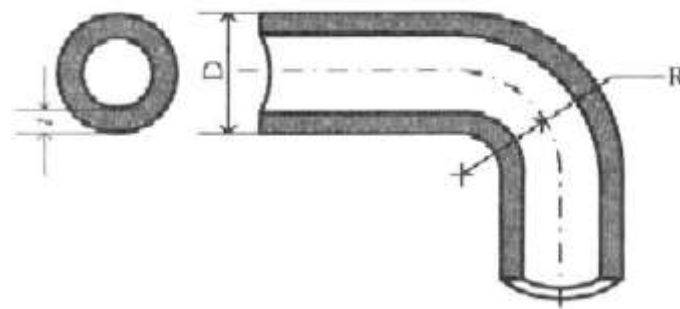

Dimensions and terms of bent tube

Several methods to bend tubes (and similar sections) are illustrated in the figure. Stretch bending is accomplished by pulling and bending the tube around a fixed form block, as in the figure (a). Draw bending is performed by clamping the tube against a form block, and then pulling the tube through the bend by rotating the block as in (b). A pressure bar is used to support the work as it is being bent. In compression bending, a wiper shoe is used to wrap the tube around the contour of a fixed form block, as seen in (c).

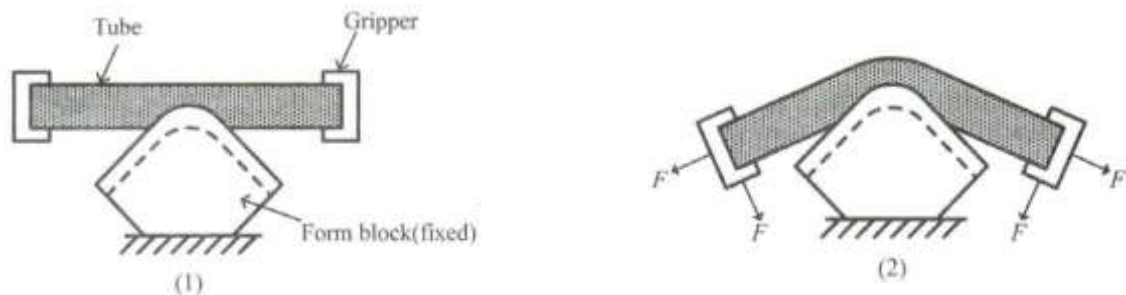

Method of bending tubes

Bending and forming tubes and other hollow sections requires special tooling because of the tendency for buckling and folding, as one notes when trying to bend a piece of copper tubing or even a plastic soda straw. The oldest method of bending a tube or pipe is to first pack its inside with loose particles (commonly sand) and then bend it into a suitable fixture. Internal mandrels or filling of tubes with particulate materials such as sand are often necessary to prevent collapse of the tubes during bending. After the tube has been bent, the sand is shaken out. Tubes also can be plugged with various flexible internal mandrels such as plug, balls, etc., for the same purpose as the sand.

Note that (because of its lower tendency for buckling) a relatively thick tube to be formed to a large bend radius can be bent safely without the use of fillers or plugs.

STRETCH FORMING

Stretch forming is a metal forming process in which a piece of sheet metal is stretched and bent

simultaneously over a die in order to form large contoured parts. Stretch forming is performed on a stretch press, in which a piece of sheet metal is securely gripped along its edges by gripping jaws. The gripping jaws are each attached to a carriage that is pulled by pneumatic or hydraulic force to stretch the sheet. The tooling used in this process is a stretch form block, called a form die, which is a solid contoured piece against which the sheet metal will be pressed. As the form die is driven into the sheet, which is gripped tightly at its edges, the tensile forces increase and the sheet plastically deforms into a new shape. Stretch forming equipment is used to produce aluminium parts for the automobile industry or titanium parts for aerospace applications. Stretch formed parts are also used in household appliances and various sheet metal applications.

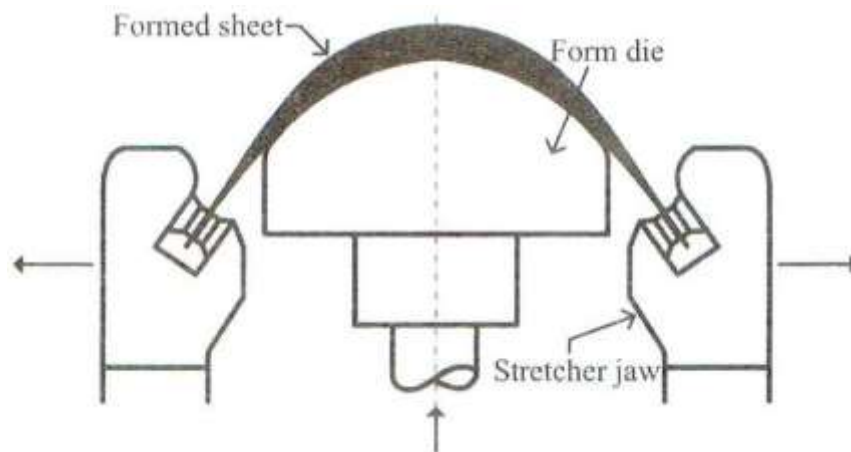

Stretch forming

SHEAR SPINNING

In conventional spinning, a circular blank of flat or preformed sheet metal is placed and held against a mandrel and rotated while a rigid tool deforms and shapes the material over the mandrel. Ornaments in copper and brass, musical instruments, cooking utensils (pots), are produced by spinning. Shear spinning is a process related to conventional spinning and is also known as spin forging. In a conventional spinning operation the work is essentially formed by bending. There is usually not much change in the thickness of the sheet metal. Shear spinning involves forming the work over the mandrel, causing metal flow within the work. This metal flow will act to reduce the thickness of the work as it is formed. The initial diameter of the work can be smaller in shear spinning. One or two rollers, (tools), may be used, two will provide a better balance of forces during the operation. This operation produces an axis-symmetric conical or curvilinear shape. Typical parts made are rocket motor casings and missile nose cones.

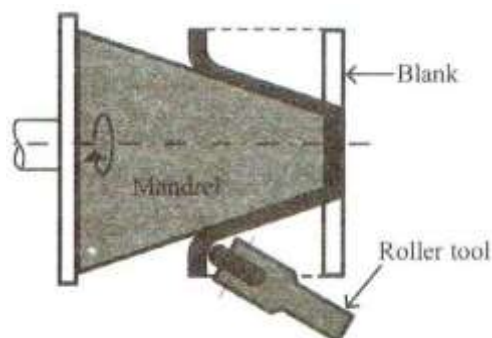

Shear spinning

TUBE SPINNING

Tube spinning is performed on cylindrical parts. Tube spinning is similar to shear spinning in that metal flow occurs within the work. This metal flow acts to reduce the thickness of the metal. While using tube spinning to reduce the thickness of the tube, the tube's length will be increased. This manufacturing process can be performed externally with the tube over a mandrel (a) or internally with the tube enclosed by a die (b). The tool can also in some cases be moved (forward and backward) during the operation, in order to create contours or features on the inside or outside of the tube. Tube spinning can be used to make rocket, missile, and jet engine parts, pressure vessels, and automotive components, such as car and truck wheels.

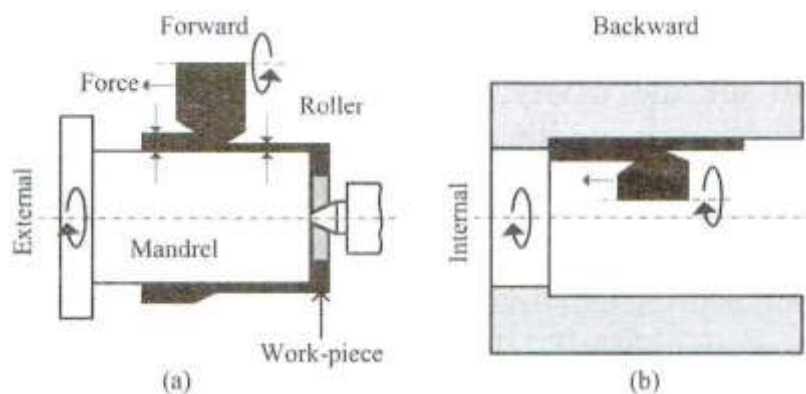

Tube spinning

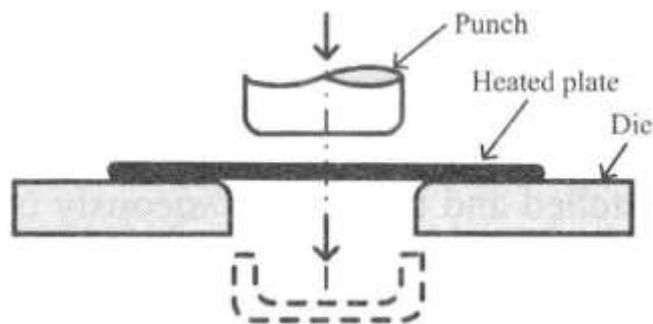

Deep drawing

Deep drawing is the process of forming a flat metal piece into a cup shape by means of a punch which causes the metal piece to flow into the die cavity. Specifically, if the depth of the item created is equal to or greater than the radius of die, then process is called deep drawing. During operation, the flat metal piece is placed over a circular die opening. The punch moves down and forces the blank into the die cavity. During operation the flat metal piece is placed over a circular die opening. The punch moves down and forces the blank into the die cavity. The punch and die setup is somewhat similar to a sheet metal cutting operation, such as punching or blanking. Two main factors will cause the punch in deep drawing to draw the metal into the die cavity, rather than shearing it.

One major factor in deep drawing is the die corner radius and the punch corner radius. When cutting sheet metal, the punch and die edges do not have a radius. Sharp corners on the punch and die cause it to cut. A radius on an edge will change the force distribution and cause the metal to flow over the radius and into the die cavity. The other major factor causing the punch to draw the sheet metal and not cut it is the amount of clearance. Clearance in cutting operations is relatively small, usually 3% to 8% of sheet metal thickness. In deep drawing manufacture, if the clearance is too small the sheet may be cut or pierced, despite the radius. Clearance in deep drawing manufacture is greater than sheet thickness, usually clearance values are 107% to 115% of sheet thickness. For many calculations the sheet metal thickness is assumed to remain constant. However, there are changes in thickness in certain areas, due to the forces involved.

During the drawing operation, the movement of the blank into the die cavity induces compressive circumferential (hoop) stresses in the flange, which tend to cause the work-piece to wrinkle during drawing. Wrinkling can be reduced or eliminated if the work-piece is loaded by a certain force. In order to improve performance, the magnitude of this force can be controlled as a function of punch travel.

Deep drawability

In a deep-drawing operation, failure generally results from the thinning of the cup wall under high longitudinal tensile stresses. If we follow the movement of the material as it flows into the die cavity, it can be seen that the sheet metal must be capable of undergoing a reduction in width due to a reduction in diameter and must also resist thinning under the longitudinal tensile stresses in the cup wall.

One of the measures of the severity of a deep drawing operation is the drawing ratio DR. This is most easily defined for a cylindrical shape as the ratio of blank diameter D_b to punch diameter D_p . In equation form, it is expressed as below.

The drawing ratio provides an indication of the severity of a given drawing operation. The greater the ratio, the more severe the operation.

REDRAWING

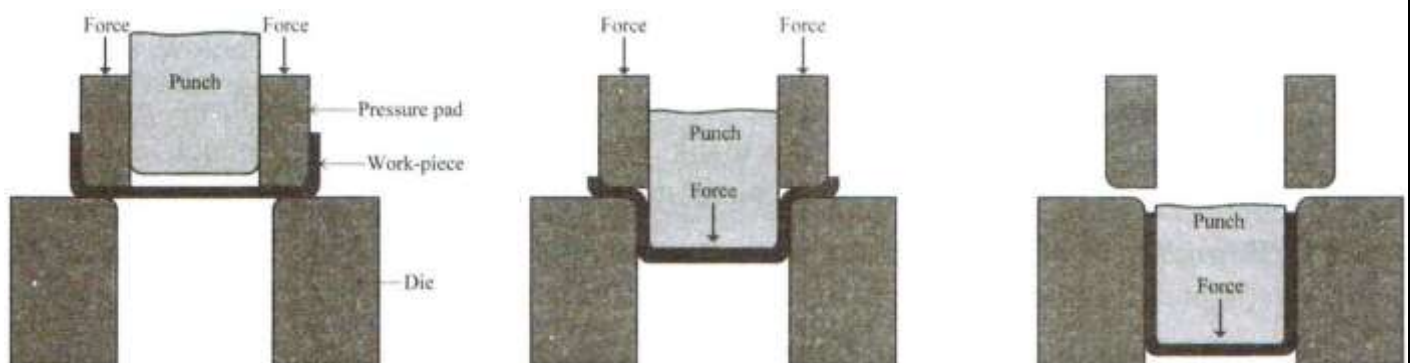

Redrawing

In redrawing, an already drawn cup is the raw material. It is further drawn in successive steps to smaller diameter and increased length. By using more than one operation, a greater magnitude of deep drawing can be accomplished. It is also called as reducing as reduction in diameter takes place. The amount of forming of the sheet metal that can be accomplished on the first redraw is less than on the original draw. If a severe amount of deep drawing is to be performed and several redrawing operations are necessary, then the part should be annealed every two operations.

IRONING

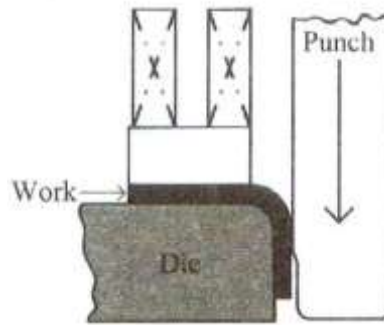

Ironing

Ironing of sheet metal is a manufacturing process that is mostly used to achieve a uniform wall thickness in deep drawings. Variation in wall thickness often exists in parts produced by deep drawing. Ironing of sheet metal can be incorporated into a deep drawing process or can be performed separately. A punch and die pushes the part through a clearance that will act to reduce the entire wall thickness to a certain value. While reducing the entire wall thickness, ironing will cause the part to lengthen. Many products undergo two or more ironing operations. Beverage cans are a common product of sheet metal ironing operations.

RUBBER FORMING

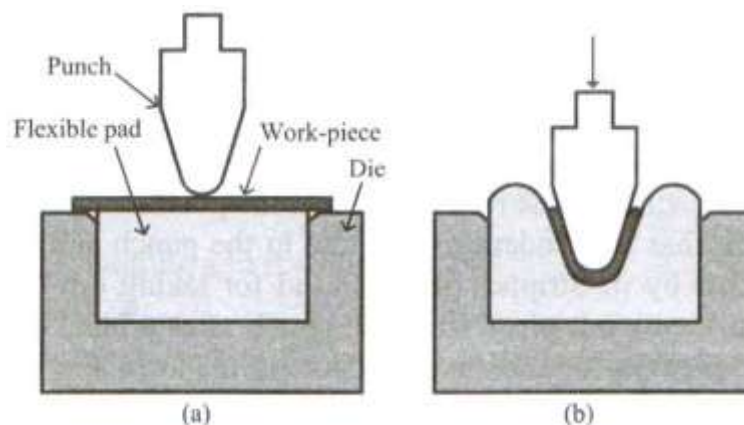

Rubber forming

In rubber forming (also known as the Guerin process), one of the dies in a set is made of a flexible material, typically a polyurethane membrane. Polyurethanes are used widely because of their abrasion resistance, fatigue life, and resistance to cutting or tearing. In the bending and embossing of sheet metal by this process as show in the figure, the female die is replaced with a rubber pad. Note that the outer surface of the sheet is protected from damage or scratches, because it is not in contact with a hard metal surface during forming. Pressures in rubber forming are typically on the order of 10 MPa. The location of the rubber can be switched between punch and die. Sheet metal parts used in aircraft industry such as frames, seat parts, ribs, windows and doors are fabricated using rubber-pad forming process.

DEFECTS IN SHEET METAL FORMED PARTS

Some of the defects encountered in sheet metal formed parts are explained below.

Burr and bend - Due to improper clearance, burr (rough surface) forms on the cut edge around the periphery

of the blank. If the clearance between punch and die is excessive, the cut periphery of the blank may bend a little.

Wrinkling - Wrinkling in the wavy condition on metal parts, due to buckling under compressive stresses.

Strain hardening- Strain hardening is a phenomenon that results in an increase in strength and hardness of a metal subject to plastic deformation (cold working at a temperature lower than its recrystallization range). Strain hardening reduces ductility (formability) and plasticity.

Orange peel effect - When a coarse grain material blank is draw, the grains will often appear themselves as a rough surface on those portions of the component which have undergone the greatest amount of deep drawing and which have not in contact with the die face.

Sinking- Sinking implies small depressions on the surfaces of the formed part which is not desirable.

Earing- Earrings are irregularities in the upper edges of the cup in deep drawing. To eliminate earing, excessive deformation in deep drawing should be avoided.

PILOTS

Pilots are used in progressive dies. In the design of progressive dies, the first step is to establish the sequence of operations. In this sequence, the piercing operations are placed first. After the holes have been pierced, these holes are used for piloting the blanking punches so that the blank formed is concentric to the already punched hole. This piloting is achieved by means of pilots secured under the blanking punch, which engage the already pierced holes.

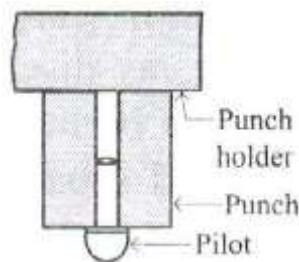

Pilots

STRIPPER PLATE

After a blank has been cut by the punch on its downward stroke, the scrap strip has the tendency to expand. On the return stroke of the punch the scrap strip has the tendency to adhere to the punch and be lifted by it. Stripper plate is used for taking out the finished work piece from the punch after a blanking or piercing operation. Provision is made in the stripper plate for the movement of punch through it. Stripper plates are of two types viz., fixed or stationary stripper and spring loaded or movable stripper. Fixed strippers are solidly attached to the die block. In spring stripper, the stripper is attached to the punch by means of two helical springs. When the punch descends, the stripper plate presses against the metal piece which is placed below the stripper plate. Then the punch descends through the hole in the stripper plate and performs the forming action. As the punch ascends, the metal piece is stripped off from the punch due to the presence of springs.

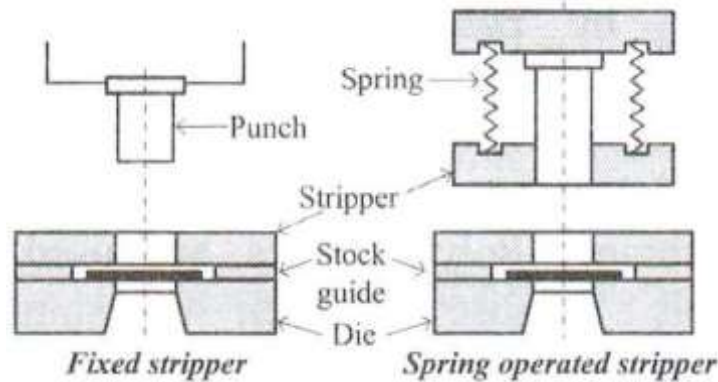

Stripper plate

MODULE VI

WELDING

Welding is the process of joining similar or dissimilar metals by the application of heat, with or without the application of pressure and with or without the addition of filler material. Filler materials are additional metal added to strengthen the coalescence (joining together). Metals being welded are called as base metals. The assemblage of parts that are joined by welding is called a weldment.

Weldability

Weldability is the capacity of a material to be welded under fabrication conditions and to perform satisfactorily in the intended service. Weldability depends up on the following factors.

1. Melting point of the metal,
2. Thermal conductivity,
3. Thermal expansion,
4. Surface condition and
5. Change in microstructure.

Classification of welding

Welding of metals can be divided into two categories.

Plastic welding - In this type of welding, the metals to be joined are to be heated to the plastic state and then forced together by external pressure without the addition of filler material. eg. forge welding, resistance welding.

Fusion welding - In this type of welding, no pressure is involved but a very high temperature is produced in or near the joint. The metal at the joint is heated to the molten state and allowed to solidify. The heat may be generated by electric arc, combustion of gases or chemical action. A filler material may be used during the welding process. eg. oxy-acetylene welding, carbon arc welding, etc.

Advantages of welding

1. Overall cost of welding equipment is low.
2. Large number of metals can be welded.
3. Welding operation can be mechanized.
4. High corrosion resistance compared to bolting and riveting.
5. Portable welding equipments are available.

Disadvantages of welding

1. Welding operation distorts (deforms) the work -pieces.
2. Skilled worker is a must to produce good weld.
3. Welded joints require heat treatment.
4. Welding produces chemical and physical changes.
5. Some welding operation gives off harmful radiations.

TYPES OF WELDING

1. Gas welding
 - a. Oxy-acetylene Welding (OAW)
 - b. Air-Acetylene Welding
 - c. Oxy-Hydrogen Welding (OHW)
 - d. Pressure Gas Welding (PGW)
2. Arc welding
 - a. Carbon-Arc Welding (CAW)
 - b. Meta/Arc Welding(MAW)
 - c. Metal-Inert-Gas Arc Welding (MIG)
 - d. Gas-Tungsten-Arc Welding (TIG)
 - e. Atomic Hydrogen Arc Welding
 - f. Plasma Arc Welding (PAW)
 - g. Submerged Arc Welding (SAW)
 - h. Flux-Cored Arc Welding (FCA W)
 - i. Electro-Slag welding (ESW)
3. Resistance welding
 - a. Resistance Butt Welding
 - b. Resistance Projection Welding (RPW)
 - c. Seam Welding (RSEW)
 - d. Spot Welding (RSW)
 - e. High Frequency Resistance Welding (HFRW)
 - f. Projection Welding
4. Thermo chemical welding process
 - a. Thermit Welding (TW)
5. Solid state welding
 - a. Friction Welding (FRW)
 - b. Explosive Welding (EXW)
 - c. Ultrasonic Welding (USW)

- d. Diffusion Welding (DFW)
- 6. Radiant energy welding
 - a. Electron Beam Welding (EBW)
 - b. Laser Beam Welding (LBW)

The choice of a particular welding process will depend on the following factors.

1. Type of metal and its metallurgical characteristics.
2. Types of joint, its location and welding position.
3. End use of the joint.
4. Cost of production.
5. Structural (mass) size.
6. Experience and abilities of manpower.
7. Joint accessibility.
8. Joint design.
9. Accuracy of assembling required.
10. Welding equipment available.
11. Work sequence.
12. Welder skill.

GAS WELDING

Oxy Fuel Gas Welding (OFW) is a general term used to describe any welding process that uses a fuel gas combined with oxygen to produce a flame. Gas welding is a fusion-welding process. It joins metals using the heat of combustion of oxygen/air and fuel gas (acetylene, hydrogen, propane or butane). The most common gas welding process uses acetylene fuel is known as oxyacetylene welding and is used typically for structural sheet-metal fabrication and automotive bodies and various other repair works. Temperature produced ranges from 2600 °C to 3300°C. The intense heat produced melts and fuses together the edges of parts to be welded, generally with the addition of filler material.

ADVANTAGES OF GAS WELDING

1. Oxy-fuel gas can be easily controlled.
2. It can weld most common materials.
3. Cost is low.
4. Welder has considerable control over the temperature of the metal in the weld zone.

DISADVANTAGES OF GAS WELDING

1. Heavy sections cannot be joined.
2. Metals having high melting points (eg. tungsten, molybdenum) cannot be gas welded.
3. Fluxes used produce fumes that are irritating to eyes, nose and lungs.
4. It is slower than arc welding process.
5. Distortion to the work piece is more compared to arc welding process.
6. Equipment and gases are expensive.
7. Careful handling and storing is required.

APPLICATIONS OF GAS WELDING

1. It is used for joining thin sections.

2. It is used in automobile and aircraft industry.
3. It is used for joining various ferrous and non-ferrous metals.

FUELS USED IN GAS WELDING

Oxy-fuel processes may use a variety of fuel gases, the most common being acetylene. Other gases that may be used are hydrogen, propane, etc. Flame temperature and costs are major factors in selecting a fuel gas. The oxyacetylene combination produces the highest temperature (3200 °C), the other gases are cooler (Oxy-hydrogen -2500 °C, Oxy-propane 2500 °C) and their flames are less concentrated. Acetylene is unstable at a pressure roughly equivalent to 10 meters underwater, so, water submerged cutting and welding is reserved for hydrogen rather than acetylene. Propane is mostly used in brazing, soldering, and cutting operations than for welding. In all the oxy-fuel gas welding processes, the combustion takes place in two stages.

OXY-ACETYLENE WELDING

Oxy-acetylene gas welding process is widely used commercially for welding of ferrous and non-ferrous metals particularly for thin sections up to 6 mm thick.

Oxy-acetylene welding works on the principle that when acetylene gas is mixed with oxygen in correct proportions in the welding torch and ignited, the flame resulting at the tip of the torch is sufficiently hot to melt and join the parent metal. The oxy-acetylene flame reaches a temperature about 3200 °C which is sufficient to melt all commercial metals. A pool of metals to be joined which upon solidification forms a bond. Filler metals are additional metal added to the weld. The composition of filler rod is same or nearly the same as that of the part being welded. Filler metal (welding rod) added increases the strength of the bond formed. Flux is added to remove the impurities and oxides formed during welding operation.

IMPORTANT PARTS OF OXY-ACETYLENE WELDING EQUIPMENT

Acetylene cylinder

Acetylene cylinder is painted maroon and the valves are screwed left handed. Usual sizes of acetylene cylinder are around 2800 and 5600 litres. Mild steel cylinder is charged to a pressure of 15.5 bar.

Oxygen cylinder

Oxygen cylinders are painted black and the valves are screwed right handed. Usual sizes of oxygen cylinder are around 3400 and 6800 litres. Mild steel cylinder is charged to a pressure of 136.6 bar.

Oxygen and acetylene pressure regulators

The pressure of the gases obtained from the cylinders is considerably higher than the gas pressure required to carry out the welding operation. The purpose of regulators is to reduce the pressures of gases and to produce steady flow of gases.

Welding torch or blow pipe

Oxygen and the fuel gas are mixed in the welding torch. Welding torch controls the flow of gases to the welding nozzle.

Welding rods

Welding rods is used as filler metal. The composition of filler rod is same or nearly the same as that of the part being welded. Filler metal added increases the strength of the bond formed as additional metal is melted and allowed to solidify.

Flux

During welding, if the metal is heated / melted in air, oxygen from air combines with the metal to form oxides which result in poor quality, low strength welds. The flux metal is fusible and is non-metallic. Fluxes are available as powders, pastes or liquids. Flux chemically reacts with the oxides and a slag is formed. Slag floats over the molten metal which is later removed. Flux also act as a cover preventing oxygen and other gases to enter the molten pool. After welding, slag is removed by chipping, or grinding. Compositions of flux are borates, borax, etc.

FLAME CHARACTERISTICS

The correct type of flame is essential for the production of satisfactory welds. As only the valve for acetylene in the torch is opened initially, it gives only acetylene flame only. Oxygen required for the flame is obtained from the atmosphere. From acetylene flame, abundance of free carbon is released into the atmosphere. Acetylene flame is used to apply carbon to the mould surfaces in the foundry.

Neutral flame (*Acetylene and oxygen in equal proportion*)

Neutral flame is produced when equal volumes of oxygen and acetylene are mixed in the welding torch and burnt at the torch tip. Oxygen to acetylene ratio is 1.1 to 1. The temperature of the flame (inner cone) is of the order about 3260 °C. The flame has defined inner cone which is light blue in colour. The neutral flame has a clear, well-defined, or luminous cone indicating that combustion is complete. It is surrounded by an outer flame envelop which is darker blue than the inner cone. Envelop is usually darker blue in colour. Most of the welding operation uses the neutral flame. Neutral flame is used for the welding of mild steel, stainless steel, cast iron, copper, aluminium, etc.

Oxidizing flame (Excess of oxygen)

Oxidizing flame is produced when excess of oxygen and acetylene are mixed in the welding torch and burnt at the torch tip. Oxygen to acetylene ratio is 1.5 to 1. Oxidizing flame bums with a loud roar. The temperature of the flame is of the order about 3482 °C. High temperature is due to presence of excess of oxygen. The flame has an inner cone pointed and darker blue in colour than in neutral flame. Outer cone is usually darker blue in colour and is shorter. When oxidizing flame is used, the excess oxygen oxidises the metal and is the reason why it is not be used for welding of steel. The oxidizing flame is used where maximum temperature is desired or in situations where oxidizing effect is not harmful. Oxidizing flame is used for the welding of copper and copper based alloys.

Reducing flame or Carburizing flame (Excess of acetylene)

Reducing flame is produced when oxygen supplied is reduced. Excess of acetylene results in free carbon which get deposited in the metal. The temperature of the flame is of about 3037°C. Reducing flame is recognized by acetylene feather having pale green colour existing between the inner cone and the outer cone. The flame has an inner cone which is dark blue in colour. It is surrounded by an outer flame envelop. Outer flame is longer than that of neutral flame and is much brighter in colour. Envelop is usually darker blue in colour. Reducing flame is (eg., non-ferrous metals) that do not absorb carbon.

Welding techniques in gas welding

Depending upon which welding rod and the welding torch may be used, there are two usual techniques in gas welding, viz., leftward techniques or forehand welding method and rightward technique or backhand welding method.

Leftward technique (forehand welding method)

In this method, the welder torch is held in right hand and filler rod in the left hand. The welding torch is

directed towards the un-welded part of the joint. Filler rod is directed towards the welded part of the joint. Welding begins from the right side of the joint and proceeds towards the left side. Since the flame is pointed in the direction of welding, it preheats the joint to be welded. Good control and neat appearance are the features of leftward method. Leftward technique is used to weld thin metal; usually metals having thickness below 6 mm. Filler metal consumed is more in leftward technique. Oxide formation is more in leftward technique.

Rightward technique (backhand welding method)

In this method also, the welder torch is held in right hand and filler rod in the left hand. The welding torch is directed towards the completed weld and the filler metal remains between the flame and the completed weld section. During welding, the filler rod is moved in circles or semi circles. Welding begins from the left side of the joint and proceeds towards the right side. Since the flame is pointed to the welding joint, thicker or heavier base metals can be welded. Rightward Technique is used to weld thick metals, usually metals having

thickness above 5 mm. No bevel is necessary for plate having thickness up to 8.2 mm. Filler metal consumed is less in rightward technique. Oxide formation is less in rightward technique.

Leftward technique	Rightward technique
t is used for welding thin sections (having thickness below 6 mm)	Thicker or heavier base metals can be welded (having thickness above 6 mm).
Oxide formation is more	Oxide formation is less
Filler metal consumed is more	Filler metal consumed is less
For thickness over 3 mm, it is necessary to bevel (edge preparation).	No bevel is necessary for plate having thickness up to 8.2 mm.

FILLER METALS USED IN GAS WELDING

Filler metals are additional metal added to the weld. The composition of filler rod is same or nearly the same as that of the part being welded. Filler metal (welding rod) added increases the strength of the bond formed as additional metal is melted and allowed to solidify. Filler metal is usually available in the rod form.

FLUXES USED IN GAS WELDING

During welding, if the metal is heated/melted in air, oxygen from air combines with the metal to form oxides which result in poor quality, low strength welds. The flux metal is fusible and is non-metallic. Fluxes are available as powders, pastes or liquids. Flux chemically reacts with the oxides and a slag is formed. Slag floats over the molten metal which is later removed. Flux also act as a cover preventing oxygen and other gases to enter the molten pool. After welding, slag is removed by chipping, filing or grinding. Flux consists of borates, potassium chloride, lithium chloride, borax, etc.

REQUIREMENT OF A GOOD FLUX

1. Should have a lower melting point than the base metal.
2. Should protect the weld from surroundings.
3. Should not cause corrosive action to the weld.
4. Should help the formation of slag.

ARC WELDING

Arc welding is one of the most widely used welding process. Arc welding is a fusion process for joining metals and alloys. In arc welding, the surfaces to be joined are fused by the heat produced from an electric arc. Electric arc is provided by AC or DC power source. A metal electrode is used for obtaining an arc between the metal parts to be joined and electrode. The electrode is allowed to touch the joint faces of the metal parts to be joined and is quickly removed to create a gap (2 mm to 4 mm) such that current continues to flow through a path of ionized particles called plasma. An electric arc is produced due to this and which may generate a temperature up to 6000°C to 7000°C at

the centre of the arc depending up on the electrode. Intense heat so produced melts the faces of the prepared joint forming a pool of molten metal. In most of the cases the electrode is also melted and is transferred across the arc to the molten metal pool. The arc is maintained by uniformly moving the electrode towards the work piece and hence keeping a constant gap between the electrode and work piece. At the same time the electrode is moved along the desired line of welding. On solidification this forms a joint between the two parent metals. The blast of arc forces the molten metal out of the pool around forming a depression in the parent metal, around which there is molten metal. This is known as arc crater. Giving a side to side motion to the welding arc during transferring material to the joint to be welded is referred to as weaving. Weaving helps to avoid slag entrapment, reduces chances of porosity and helps to have better fusion of the weld. Generally, electrodes are coated with a slagging or fluxing materials. This provides a gas shield around the arc to prevent direct contact of oxygen and nitrogen in the air with the deposited metal. It also covers the weld metal with a protective slag coating which prevents the oxidation of weld metal during cooling. The slag is brushed off after cooling.

ARC WELDING ELECTRODES

Electrodes can be classified into non-consumable electrodes and consumable electrodes. The composition of electrode depends up on the metal to be welded. For example, for welding mild steel, electrode of similar composition is used so as to get a homogeneous weld joint. The size (diameter) of electrode depends up on the amount of weld metal to be deposited and the gap between the two plates to be welded. Higher currents will be required when bigger diameter electrodes are used.

Non-consumable electrodes

Non-consumable electrodes are those electrodes, which do not get consumed during the welding process. Separate filler metals are necessary to fill the gap between the joints. Non-consumable electrodes are made up of higher melting point materials like carbon, graphite or pure tungsten), thoriated (thorium increases the electron emission qualities) or zirconiated tungsten electrodes (produces an extremely stable arc). Carbon and graphite electrodes are used only with DC welding, where as tungsten electrodes are used for AC and DC welding. Nonconsumable electrodes are used in carbon arc welding and TIG welding. Using nonconsumable electrodes, good control over the process is possible. The electrode length goes on decreasing with the passage of time, because of the vaporization and oxidation of electrode material during welding. As compared to carbon electrodes, tungsten electrodes are more expensive and alloy tungsten electrodes are still more costly. Alloying tungsten increases emissivity, resistance to contamination and arc stability.

Consumable electrodes

Consumable electrode is consumed during welding operation. Consumable electrode possesses more thermal efficiency than nonconsumable electrode. It may be made of various metals depending upon the purpose and chemical composition of the metals to

be welded. Bare electrodes are used in coil form without coating as in MIG welding. Metal arc welding make use of coated electrode. Commonly used core wire materials are mild steel, low alloy steel, nickel steel, etc. Consumable electrodes may be classified as follows.

a) Bare electrodes -In bare electrodes, there won't be any coating of flux. Arc produced by bare electrode is unstable. Joint produced by bare electrodes are not strong enough. Also, irregular metal transfer and atmospheric contamination takes place. Bare electrodes are used when strength is not a concern.

b) Coated electrodes - Molten metal is exposed to oxygen and nitrogen in the atmosphere and so undesirable oxides and other substances decreasing the strength of the weld formed. Coated electrodes (flux coated) are used to prevent the formation of oxidizes and helps to form slag. Due to flux coating, the molten metal is not exposed to oxygen and nitrogen in the atmosphere resulting in strong bond. Coated electrodes produce very good weld appearances and defect free joints. Commonly used fluxes are asbestos, mica, silica etc. Coated electrodes are again classified as lightly coated electrodes (coating less than 1 mm) and heavily coated electrodes (thick coating of flux).

Selection of welding electrodes is critical. It depends on factors such as availability of current, composition of base metal, thickness of base metal, welding position-flat, horizontal vertical, etc., amount of penetration required in welding, etc.

WELDING ARC

Welding arc has been defined as a sustained electrical discharge through an ionized gas. The discharge is initiated by an avalanche (sudden large amount) of electrons emitted from the hot cathode and maintained by thermal ionization of the hot gas. This electrical discharge through an ionized gas (or a high temperature conducting plasma) produces a good amount of heat energy which is employed for joining various metals and alloys by fusion. A welding arc is a high current (up to 2000 Amps.) and low voltage (10-50 V) discharge. When arc is struck, about 50% of the electrical energy fed into the arc is converted into heat energy. Electric arc is used as heat source to melt the base metal and electrode (if consumable) in order to form a strong union between the parts to be joined.

Arc initiation

Arc is initiated by providing a conducting path between the electrode and the job or by ionizing the gap between the two. This can be achieved in the following methods:

1. In this method, the electrode is brought in contact with the work piece and then pulled apart to create a very small gap. Touching of the electrode to the workpiece causes short circuiting, resulting in flow of heavy current which in turns lead to heating, partial melting and even slight evaporation of the metal at the electrode tip (figure a).

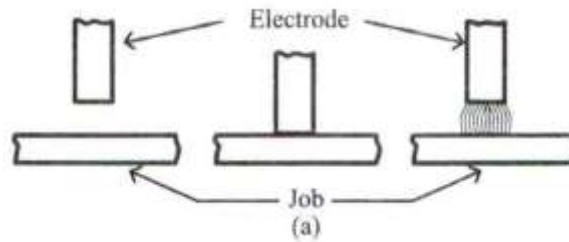

2. In this case steel wool is kept pressed between the electrode and the job. When the welding current is switched on, the steel wool provides a conducting path for the arc to establish. This method can be used in automatic submerged arc welding sets and automatic MIG welding machines (figure b).

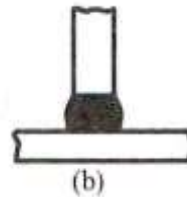

FLUX SHIELDED METAL ARC WELDING

Flux Shielded Metal Arc Welding (MMAW or SMAW) is an arc welding process in which weld is produced by heating the work-piece with an arc setup between the flux coated electrode and the work-piece. SMAW is the most commonly used welding process in fabrication and maintenance jobs. Steel when exposed to air forms oxides and nitrides. These impurities weaken the weld. To prevent this molten metal is shielded by enveloping it completely with an inert gas or flux. Arc melts the electrode and the job. The flux coating melts, produces a gaseous shield to prevent the atmospheric contamination of the molten weld metal. The electrode itself melts and supplies the necessary filler metal. The arc produced between the electrode and work-piece heats the metal to the melting temperature (about 2400- 2600 °C). Both AC and DC can be used in MMAW. The arc temperature and thus the arc heat can be increased or decreased by employing higher or lower arc currents.

ADVANTAGES OF FLUX SHIELDED METAL ARC WELDING

1. Flux shielded metal arc welding is the simplest of all the arc welding process.
2. Equipment is portable.
3. Big range of metals and alloys can be welded.
4. Good weld quality can be obtained.
5. Cost is fairly low.

DISADVANTAGES OF FLUX SHIELDED METAL ARC WELDING

1. Mechanization is difficult due to the limited length of electrode.
2. Due to the limited length of electrode, the welding needs to be restarted with a new electrode. Unless properly cared, defect may occur at the place where welding is restarted.
3. Process is slow.

4. Because of fumes and particles of slag, the arc and metal transfer is not clear and thus welding control is difficult.

APPLICATIONS OF FLUX SHIELDED METAL ARC WELDING

The process finds applications in air receiver, tank, boiler and pressure vessel fabrications, ship building, pipes and penstock joining, building and bridge construction, automotive and aircraft industry, etc.

Metal-Inert-Gas Arc Welding (MIG) or Gas Metal Arc Welding (GMA)

MIG or GMA make use of the high heat produced by the electric arc between the consumable electrode and material to be welded. The electrode is continuously fed through a gun. The current ranges from 100A to 400A depending upon the diameter of the wire. The wire is fed at the rate up to up to 5 m/min. Usually, constant voltage DC machine is used for MIG Welding. Welding Gun is either water cooled or air cooled. Welding wire is often bare. Argon or argon helium mixtures are often used as shielding gases. Shielding is done to prevent contamination of weld.

ADVANTAGES OF MIG WELDING

1. MIG welding can be used to weld ferrous and non-ferrous metals.
2. MIG welding does not require much skill.
3. Continuous welding at high speeds can be carried out.
4. Deeper penetration is possible.
5. Thick and thin sections can be welded easily.
6. Large metal deposition rates can be obtained.
7. No flux is used.
8. Faster compared to TIG and metal arc welding.

DISADVANTAGES OF MIG WELDING

1. Welding equipment is much complex.
2. Difficult to weld small corners.

APPLICATIONS OF MIG WELDING

1. MIG welding is used for welding of carbon, silicon and low alloy steels, stainless steels, aluminum, magnesium, copper, nickel and their alloys, titanium, etc.
2. MIG welding is used for the manufacture of refrigerator parts.
3. Used in industries like aircraft, automobile, pressure vessel and ship building.

CO₂ welding or Metal Active Gas welding (MAG)

MAG is a variation of the standard MIG process. Argon, helium or their mixtures used a

shielding gas in MIG welding is replaced by carbon dioxide in CO₂ welding. CO₂ welding is done in the similar way as MIG welding i.e., the welding wire wound in coil is fed into the welding torch by the feeding motor automatically. CO₂ gas supplied through the nozzle of the welding torch shield the weld pool. CO₂ gas gets decomposed by the ultra-high temperature arc heat into CO and O near the arc.

Features of CO₂ welding

Higher fusion, higher welding speeds and elimination of welding defects such as lack penetration and lack of fusion are the features of CO₂ welding. CO₂ welding is cheaper than MIG welding. The deposition efficiency is high and formation of slag is little, which makes it unnecessary to remove slag after each pass. The CO₂ process is commonly used for welding carbon and low alloy steels.

Gas-Tungsten-Arc Welding (GTAW) or Tungsten Inert Gas Welding (TIG)

GTAW or **TIG** is a shielded metal arc welding process. TIG welding makes use of the high heat produced by the electric arc between the non-consumable tungsten electrode and material to be welded.

The equipment required for the TIG welding operation includes a welding torch utilizing a non-consumable tungsten electrode, a constant-current welding power supply, and a shielding gas source. Tungsten electrode is used only to generate the arc. Because the tungsten electrode is not consumed in the operation, a constant and a stable arc gap is maintained at constant current level. Filler metal may be or may not be used. Shielding is obtained by an inert gas such as helium or argon or mixture of two. Shielding is done to prevent contamination of weld. Usually AC machine is used for TIG Welding (for nonferrous alloys) except for ferrous alloys DC is used. End of the welding gun is water cooled. Leftward welding technique is usually used for the process.

Manual gas tungsten arc welding is often considered the most difficult of all the welding processes commonly used in industry. Because the welder must maintain a short arc length, great care and skill are required to prevent contact between the electrode and the workpiece. Unlike other welding processes, GTAW normally requires two hands, since most applications require that the welder manually feed a filler metal into the weld area with one hand while manipulating the welding torch in the other.

Base metals welded using TIG are carbon and alloy steels, stainless steels, heat resisting alloys, refractory metals, aluminum alloys, copper alloys, magnesium alloys, nickel alloys, etc.

ADVANTAGES OF GTAW

1. No flux is needed.
2. Clear visibility of arc.
3. Smooth welds can be obtained.

DISADVANTAGES OF GTAW

1. Under similar applications MIG is faster than TIG.

2. Tungsten if transferred can contaminate the weldment.
3. Costly.

APPLICATIONS OF GTAW or TIG

1. Used extensively in the manufacture of space vehicles.
2. Used to weld small- diameter, thin-wall tubing.
3. TIG welding is used for welding sheet metals and thinner sections.
4. TIG welding is used in precision welding in atomic energy, aircraft and instrument industries.

PLASMA ARC WELDING

Plasma arc welding is an arc welding process in which coalescence (joint) is produced by the heat obtained from a constricted arc setup between a tungsten/tungsten alloys electrode and water cooled nozzle or between a tungsten electrode and the work-piece. Plasma arc welding is a shielded metal arc process. Plasma is high temperature ionized gas (hydrogen or helium) conducting electricity.

When the gas is passed across an electric arc and then through a constrained opening, the gas gets ionized and become plasma. This also raises the temperature of the gas. A nonconsumable tungsten electrode, water cooled copper nozzle and gas shield (argon or argon mixtures) is employed for the welding. The process employs two inert gases, one forms the arc plasma and the second shields the arc plasma. Filler metal may or may not be used. Shielding is done to prevent contamination of weld. Temperature produced is about 10000°C to 14000° C. Narrow and deep welds can be made using this process at high welding speeds.

ADVANTAGES OF PLASMA ARC WELDING

1. Used for welding and cutting operations.
2. Used for melting high melting point metals.
3. Used for welding of stainless steels, nickel alloys, etc.
4. No edge preparation needed.
5. Process is faster.
6. Stable arc can be produced.
7. Uniform penetration can be produced.
8. Excellent weld quality.

DISADVANTAGES OF PLASMA ARC WELDING

1. Welding equipment is much complex and expensive.
2. High noise.
3. Inert gas consumption is more.
4. Process is limited to metal thickness of 25 mm and lower butt welds.
5. Radiations are produced.

FEATURES OF PLASMA ARC WELDING

The manufacture of tubing (stainless steel, titanium alloy). Tubing made of stainless steel, titanium, and other metals is being produced with the plasma process at higher production rates than previously with gas tungsten arc welding. This process is also used to do work similar to electron beam welding, but with a much lower equipment cost. The plasma welding process is able to join practically all commercially available metals.

CLASSIFICATION OF PLASMA ARC WELDING

Plasma arc welding can be divided into two basic type viz., nontransferred arc process and transferred arc process.

Non transferred arc process:

In non-transferred arc process, the arc is formed between workpiece (+) and electrode (-). Non transferred arc process possesses more energy compared to transferred arc process. Non-transferred arc process makes use of a current limiting resistor to generate this arc. It is used for cutting metals.

Transferred arc process:

In transferred arc process, the arc is formed between water cooled constricting nozzle (+) and electrode (-). Transferred arc process possesses comparatively less energy. It is initiated by a high frequency unit in the circuit. It is used for welding applications and metal plating.

Comparison between plasma arc welding and TIG welding

S No.	Plasma arc welding	TIG welding
1.	It is a constricted arc process.	It is a non-constricted arc process.
2.	Uses two inert gases, one forms the arc plasma and the second shields the arc plasma.	Uses only one gas.
3.	Electrode remains within the nozzle, therefore tungsten inclusion and electrode contamination are nil.	Chances of tungsten inclusion and electrode contamination.
4.	Filler metal requirement are less.	More.
5.	Faster metal deposition.	Slow metal deposition.
6.	Total welding time is less.	More.

Comparison between TIG welding and MIG welding

S No.	TIG welding	MIG welding
1.	TIG uses non-consumable tungsten electrode.	Uses continuous coil electrode of same chemical

		composition as the material being welded.
2.	TIG welding electrode serves the purpose of producing the arc only.	MIG welding electrode serves the purpose of producing arc and filler metal.
3.	TIG is not fast as MIG.	MIG is fast
4.	Skilled labour is required.	Not required.
5.	With the use of filler metal, operators both hands are engaged.	Electrode and gas come through same gun.
6.	TIG is water cooled.	No cooling is required.
7.	It is not used for plates thicker than 6 mm.	It is suited for plates more than 6 mm.
8.	Penetration is not so deep.	Deeper penetration can be obtained.

SUBMERGED ARC WELDING (SAW) or (*hidden arc welding*) or (*subarc welding*)

SAW is an arc welding process in which coalescence (joint) is produced by heating the work-piece with an arc setup between a bare metal electrode and the work-piece. In submerged arc welding, the arc is submerged under a layer of flux and so the arc is invisible (a). **Flux** is fed through a flux hopper. The upper portion of flux is in contact with the atmosphere. The flux may be made of silica, metal oxides or other compounds. **Bare electrode** (steel stainless steel or copper, etc) is fed through the gun. The flux serves as a shield and protects the molten weld pool from atmospheric contamination. Normally DC is employed for submerged welding, but AC is also used. Instead of flux covered electrode, granular flux and a bare electrode is used. The process may be semi-automatic or automatic. In manually operated SAW process (b), the operation starts with pulling the trigger is pulled so that flux starts depositing on the joint to be welded. The arc is struck by touching the work-piece with the electrode or by using a high frequency unit. In all cases arc is struck under

the cover of flux. Flux is a non-conductor of electricity, but once it melts due to the action of heat it becomes highly conductive and hence current flow will be maintained between work-piece and electrode. Electrode at a predetermined speed is fed to the joint to be welded.

ADVANTAGES OF SAW

1. Often automated, so faster.
2. Deep penetration and high quality weld is possible.
3. Operator can work without safety equipment.
4. Wire electrodes are inexpensive.
5. No sparks, fumes and visible arc.

DISADVANTAGES OF SAW

1. Since the operator cannot see the welding being carried out, he cannot judge accurately the progress of welding.
2. SAW cannot be used for plates with less thickness.
3. Slag has to be removed continuously.
4. Can't be used for welding cast iron due to high heat input.

5. Cast iron, Al alloys, Mg Alloys, Pb and Zn cannot be welded by this process.

APPLICATIONS OF SAW

Submerged arc welding is used for welding of different grades of steels in many sectors such as shipbuilding, offshore, structural and pressure vessel industries fabrication of pipes, penstocks, LPG cylinders, and bridge girders.

RESISTANCE WELDING

Heat obtained from the resistance of the work to the flow of current in a circuit in which work is a part and by the application of pressure. No filler metal is needed for the process. Three types of current supply systems are used in resistance welding viz.,

- a) AC systems (50 Hz low voltage supply),
- b) DC systems and
- c) Stored energy systems such as storage batteries, electromagnetic type.

ADVANTAGES OF RESISTANCE WELDING

- 1) Both similar and dissimilar metals can be joined.
- 2) Less wastage of metals and less deformation of metals.
- 3) Less pollution.

DISADVANTAGES OF RESISTANCE WELDING

- 1) Initial cost is high.
- 2) In some materials, surface preparation is needed.
- 3) Work-pieces with big job thickness cannot be welded.

Resistance Butt Welding (Resistance Upset Welding)

Resistance Butt Welding is a process in which joint is produced by the heat obtained from resistance to electric current between the two surfaces and by the application of pressure.

In upset butt welding, one of the work-piece to be welded is firmly gripped to a movable clamp and other to a stationary clamp. Clamps hold the work-pieces and also conduct welding current through the work-pieces. Force is applied so that the faces of the two work-pieces touch together and remain under pressure. Force is applied by moving the work-piece fixed to the movable clamp towards the work-piece fixed to the stationary clamp. Current is allowed to flow through this joint. There will be heat generated at the point of contact due to the high resistance at the point of contact. Both pressure and current are applied throughout the process until face becomes plastic. Then the work-pieces are pressured together to form a solid joint. Upsetting takes place while the current is flowing and then the current is shut off. Work-pieces are unclamped. Resistance butt welding is used for joining small ferrous and non-ferrous wires, pipes, tubes strips, rods and so on.

Resistance spot welding

Spot welding is a process of joining overlapping sheets by the heat generated by resistance to the flow of electric current through the work-pieces held together under force by two pointed electrodes. It is used for joining relatively light gauge (less thickness) parts (up to about 3 mm thick) superimposed on one another as a lap joint.

In spot welding, the parts to be welded and electrode tips are cleaned. Water is allowed to pass through the weld to avoid overheating and cool the weld. Sheets to be welded are placed one over the other and is placed between the electrodes. Pressure is applied to the workpieces by the electrodes. Welding current is switched on for a definite period of time. The current may vary from 3000 A to 100,000 A for a fraction of seconds to few seconds depending upon the nature of material and its thickness. As the current passes through, a small area where the work-pieces are in contact is heated due to the resistance offered by the materials in the contact area. Welding current is then cut off and extra electrode force is then applied to the work-pieces. This electrode force or pressure holds together the work-pieces. The electrode pressure is then released.

Advantages of spot welding

1. Good uniformity can be obtained.
2. No edge preparation is needed.

Disdvantages of spot welding

1. The equipment cost is high so it can have an effect on the initial cost.
2. Skilled welders or technicians are needed for the maintenance and controlling.

Applications of spot welding

1. Attaching handles to stainless-steel cookware,
2. To rapid spot welding of automobile bodies etc.

Resistance seam welding

Seam welding is a process of joining overlapping sheets by the heat generated by resistance to the flow of electric current through the work-pieces held together under force by two rotating circular electrodes. It is similar to spot welding, but differs in the type of electrodes used. In seam welding, rotating circular electrodes replaces pointed electrodes in spot welding. Seam welds are produced using rotating electrodes with regularly interrupted current.

Advantages of seam welding

1. It can produce gas or air-tight liquid-tight joints.
2. Filler metals are not required. Hence no associated fumes or gases.

Disadvantages of seam welding

1. Welding can be done only along a straight or uniformly curved line.
2. Difficult to weld metals having thickness greater than 3 mm.

Applications of seam welding

1. Fabricate liquid or gas tight sheet metal vessels such as gasoline tanks, automobile mufflers, heat exchangers, etc.
2. It is also used in the production of seam welded pipes and tubing.

STUD WELDING

The stud welding is type of an arc welding process where the coalescence is obtained by heating with an electrical arc between the *metal studs* or similar parts and *base metals*. The stud (which may be a small part or, more commonly, a threaded rod, hanger, or handle) serves as one of the electrodes while being joined to another component, which is usually a flat plate. In order to concentrate the heat generated, prevent oxidation, and retain the molten metal in the weld zone, a disposable *ceramic ring (ferrule)* is placed around the joint. Stud welding is a one step fastening method which is used in locations which do not allow the use of other fasteners.

APPLICATIONS OF STUD WELDING

1. Automobile bodies,
2. Electrical panels,
3. Ship building;
4. The process is also used in building construction.

PERCUSSION WELDING

Percussion welding is a resistance welding process in which heat required for coalescence is obtained from an *intense discharge of electrical energy* applied to the locality of the proposed weld for an *extremely short time*. Pressure is applied percussively (rapidly) during or immediately following the electrical discharge. Percussion welding machine comprise of means for converting AC from the mains into DC (in the form of a transformer and a rectifier), a capacitor as the storage medium and the welding fixture consisting of a fixed arm and a movable arm. The storage medium allows electrical energy to be stored and built up until the appropriate moment for welding. The process of percussion welding is as follows:

- The pieces to be welded are held apart, one in the fixed arm and the other in a movable arm with their end faces opposite to each other.
- By bringing them closer at a fast speed after switching on the current, a sudden discharge of electric energy takes place, when the pieces are say, 0.16 mm apart.
- This causes an instant arcing over the surface thus bringing them to fusion temperature.
- The blow of the work-piece striking with a sufficient force completes the welding and extinguishes the arc.

- The arc duration is very short, only 1 to 10 milliseconds.

APPLICATIONS OF PERCUSSION WELDING

1. Join dissimilar metals together.
2. Used when flash is not required at the joint.
3. This type of welding is limited to the materials having the same cross sectional areas and geometries.
4. Used on materials that have small cross sectional areas.
5. Percussion welding is useful where heating of the components adjacent to the joint is to be avoided, as in electronic assemblies and electrical wires.

FRICITION WELDING

Friction welding is a solid state welding process in which joint is produced by the heat obtained from mechanically induced sliding motion between rubbing surfaces. The work parts are held together under pressure. Temperatures developed are below the melting point of the metals welded but high enough to create plastic flow and intermolecular bonding. In this process, the metals to be joined are mounted in a device with one surface stationary and other is revolved under pressure. Pressure and rotation is continued until the components achieve desired temperature for plastic flow. When mating parts achieve sufficient temperature, then motion between the parts is stopped and pressure is increased to for the desired joint. Major factors that affect the weld quality and productivity of friction welding are relative speed, friction pressure, duration of heating and forge pressure.

The operational steps in friction welding are discussed below.

1. Two components to be welded are held in axial alignment.
2. One component held in chuck is rotated and accelerated to the desired speed.
3. The other component that is held stationary and held in the moving clamp is moved forward to come in contact with the rotating component.
4. Pressure and rotation are maintained until the resulting temperature makes the metals plastic for welding.
5. When sufficient heating has taken place a brake is applied to stop rotation and the axial force is further increased to forge the components together.

ADVANTAGES OF FRICTION WELDING

1. Dissimilar metals can be welded.
2. It is used for welding of non ferrous metals (pipe, tubes, etc).
3. No edge preparation is needed.
4. Low power is needed.
5. Low cost.
6. No use of flux or filler metal.

DISADVANTAGES OF FRICTION WELDING

1. Process is restricted to flat and angular welds.
2. So far process is applied to weld small pieces.

APPLICATIONS OF FRICTION WELDING

1. Joining steels, super-alloys, non ferrous metals and combinations of metals.
2. Production of steering shafts, worm gears, engine valves, cutting tools, etc.

ULTRASONIC WELDING

Ultrasonic welding (USW) is a solid state welding process in which joint is produced by the local application of oscillating shear stress of ultrasonic frequency to the work-pieces held together under pressure. Although heating of the contacting surfaces occurs due to interfacial rubbing and plastic deformation, the resulting temperatures are well below the melting point. No filler metals, fluxes, or shielding gases are required in USW. The oscillatory motion is transmitted to the upper work-pieces by means of a sonotrode, which is coupled to an ultrasonic transducer. This device converts electrical power into high-frequency vibratory motion. Frequency ranges from 15 kHz to 170 kHz. Clamping pressures are well below to produce any significant plastic deformation in the work-pieces. The shearing stresses cause plastic deformation at the interface of the two components, breaking up oxide films and contaminants and thus allowing good contact and producing a strong solid-state bond. The operation is illustrated in the figure for lap welding, the typical application.